

SPLIT-TYPE AIR CONDITIONERS

INDOOR UNIT

**MSZ-HR25VF2 MSZ-HR35VF2 MSZ-HR42VF2 MSZ-HR50VF2
MSZ-HR25VFK2 MSZ-HR35VFK2 MSZ-HR42VFK2 MSZ-HR50VFK2**



OPERATING INSTRUCTIONS

BEDIENUNGSANLEITUNG

NOTICE D'UTILISATION

BEDIENINGSINSTRUCTIES

MANUAL DE INSTRUCCIONES

LIBRETTO D'ISTRUZIONI

ΟΔΗΓΙΕΣ ΛΕΙΤΟΥΡΓΙΑΣ

INSTRUÇÕES DE OPERAÇÃO

BETJENINGSVEJLEDNING

BRUKSANVISNING

РЪКОВОДСТВО ЗА ЕКСПЛОАТАЦИЯ

INSTRUKCJA OBSŁUGI

BRUKSANVISNING

KÄYTTÖOHJEET

NÁVOD K OBSLUZE

NÁVOD NA OBSLUHU

HASZNÁLATI ÚTMUTATÓ

NAVODILA ZA UPORABO

INSTRUCȚIUNI DE UTILIZARE

KASUTUSJUHEND

LIETOŠANAS INSTRUKCIJAS

NAUDOJIMO INSTRUKCIJA

UPUTE ZA UPORABU

UPUTSTVA ZA RUKOVANJE

ІНСТРУКЦІЇ З ЕКСПЛУАТАЦІЇ

English

Deutsch

Français

Nederlands

Español

Italiano

Ελληνικά

Português

Dansk

Svenska

Български

Polski

Norsk

Suomi

Čeština

Slovenčina

Magyar

Slovenščina

Română

Eesti

Latviski

Lietuviškai

Hrvatski

Srpski

Українська

SPECIFICATIONS

CONTENTS

■ SAFETY PRECAUTIONS	1
■ DISPOSAL	3
■ NAME OF EACH PART	4
■ PREPARATION BEFORE OPERATION	5
■ SELECTING OPERATION MODES	6
■ FAN SPEED AND AIRFLOW DIRECTION ADJUSTMENT	7
■ ECONO COOL OPERATION	8
■ NIGHT MODE OPERATION	8
■ TIMER OPERATION (ON/OFF TIMER)	9
■ EMERGENCY OPERATION	9
■ AUTO RESTART FUNCTION	9
■ CLEANING	10
■ Wi-Fi INTERFACE SETTING UP (VFK type only)	11
■ WHEN YOU THINK THAT TROUBLE HAS OCCURRED	12
■ WHEN THE AIR CONDITIONER IS NOT GOING TO BE USED FOR A LONG TIME	13
■ INSTALLATION PLACE AND ELECTRICAL WORK	13
■ SPECIFICATIONS	SPECIFICATIONS

EN

SAFETY PRECAUTIONS

Meanings of symbols displayed on indoor unit and/or outdoor unit

	WARNING (Risk of fire)	This unit uses a flammable refrigerant. If refrigerant leaks and comes in contact with fire or heating part, it will create harmful gas and there is risk of fire.
	Read the OPERATING INSTRUCTIONS carefully before operation.	
	Service personnel are required to carefully read the OPERATING INSTRUCTIONS and INSTALLATION MANUAL before operation.	

- Since rotating parts and parts which could cause an electric shock are used in this product, be sure to read these "Safety Precautions" before use.
- Since the cautionary items shown here are important for safety, be sure to observe them.
- After reading this manual, keep it together with the installation manual in a handy place for easy reference.
- Wi-Fi® is a registered trademark of Wi-Fi Alliance®.

Marks and their meanings

- WARNING :** Incorrect handling could cause serious hazard, such as death, serious injury, etc. with a high probability.
- CAUTION :** Incorrect handling could cause serious hazard depending on the conditions.





Meanings of symbols used in this manual

- : Be sure not to do.
- : Be sure to follow the instruction.
- : Never insert your finger or stick, etc.
- : Never step onto the indoor/outdoor unit and do not put anything on them.
- : Danger of electric shock. Be careful.
- : Be sure to disconnect the power supply plug from the power outlet.
- : Be sure to shut off the power.
- : Risk of fire.
- : Never touch with wet hand.
- : Never splash water on the unit.

WARNING	
	<p>Do not connect the power cord to an intermediate point, use an extension cord, or connect multiple devices to a single AC outlet.</p> <ul style="list-style-type: none"> • This may cause overheating, fire, or electric shock.
	<p>Make sure the power plug is free of dirt and insert it securely into the outlet.</p> <ul style="list-style-type: none"> • A dirty plug may cause fire or electric shock.
	<p>Do not bundle, pull, damage, or modify the power cord, and do not apply heat or place heavy objects on it.</p> <ul style="list-style-type: none"> • This may cause fire or electric shock.
	<p>Do not turn the breaker OFF/ON or disconnect/connect the power plug during operation.</p> <ul style="list-style-type: none"> • This may create sparks, which can cause fire. • After the indoor unit is switched OFF with the remote controller, make sure to turn the breaker OFF or disconnect the power plug.



	<p>Do not expose your body directly to cool air for a prolonged length of time.</p> <ul style="list-style-type: none"> • This could be detrimental to your health.
	<p>The unit should not be installed, relocated, disassembled, altered, or repaired by the user.</p> <ul style="list-style-type: none"> • An improperly handled air conditioner may cause fire, electric shock, injury, or water leakage, etc. Consult your dealer. • If the power supply cord is damaged, it must be replaced by the manufacturer or its service agent in order to avoid a hazard.
	<p>When installing, relocating, or servicing the unit, make sure that no substance other than the specified refrigerant (R32) enters the refrigerant circuit.</p> <ul style="list-style-type: none"> • Any presence of foreign substance such as air can cause abnormal pressure rise and may result in explosion or injury. • The use of any refrigerant other than that specified for the system will cause mechanical failure, system malfunction, or unit breakdown. In the worst case, this could lead to a serious impediment to securing product safety.

SAFETY PRECAUTIONS

	<p>This appliance is not intended for use by persons (including children) with reduced physical, sensory or mental capabilities, or lack of experience and knowledge, unless they have been given supervision or instruction concerning use of the appliance by a person responsible for their safety.</p> <p>Children should be supervised to ensure that they do not play with the appliance.</p>
	<p>Do not insert your finger, a stick, or other objects into the air inlet or outlet.</p> <ul style="list-style-type: none"> This may cause injury, since the fan inside rotates at high speeds during operation.
	<p>In case of an abnormal condition (such as a burning smell), stop the air conditioner and disconnect the power plug or turn the breaker OFF.</p> <ul style="list-style-type: none"> A continued operation in the abnormal state may cause a malfunction, fire, or electric shock. In this case, consult your dealer.
	<p>When the air conditioner does not cool or heat, there is a possibility of refrigerant leakage. If any refrigerant leakage is found, stop operations and ventilate the room well and consult your dealer immediately. If a repair involves recharging the unit with refrigerant, ask the service technician for details.</p> <ul style="list-style-type: none"> The refrigerant used in the air conditioner is not harmful. Normally, it does not leak. However, if refrigerant leaks and comes in contact with fire or heating part of such a fan heater, kerosene heater, or cooking stove, it will create harmful gas and there is risk of fire. <p>The user should never attempt to wash the inside of the indoor unit. Should the inside of the unit require cleaning, contact your dealer.</p> <ul style="list-style-type: none"> Unsuitable detergent may cause damage to plastic material inside the unit, which may result in water leakage. Should detergent come in contact with electrical parts or the motor, it will result in a malfunction, smoke, or fire. The appliance shall be stored in a room without continuously operating ignition sources (for example: open flames, an operating gas appliance or an operating electric heater). Be aware that refrigerants may not contain an odour. Do not use means to accelerate the defrosting process or to clean the appliance, other than those recommended by the manufacturer. Do not pierce or burn. <p>The indoor unit must be installed in rooms which exceed the floor space specified. Please consult your dealer.</p>
	<p>This appliance is intended to be used by expert or trained users in shops, in light industry and on farms, or for commercial use by lay persons.</p>

CAUTION

	<p>Do not touch the air inlet or the aluminum fins of the indoor/outdoor unit.</p> <ul style="list-style-type: none"> This may cause injury.
	<p>Do not use insecticides or flammable sprays on the unit.</p> <ul style="list-style-type: none"> This may cause a fire or deformation of the unit.
	<p>Do not expose pets or houseplants to direct airflow.</p> <ul style="list-style-type: none"> This may cause injury to the pets or plants.
	<p>Do not place other electric appliances or furniture under the indoor/outdoor unit.</p> <ul style="list-style-type: none"> Water may drip down from the unit, which may cause damage or malfunction.
	<p>Do not leave the unit on a damaged installation stand.</p> <ul style="list-style-type: none"> The unit may fall and cause injury.
	<p>Do not step on an unstable bench to operate or clean the unit.</p> <ul style="list-style-type: none"> This may cause injury if you fall down.
	<p>Do not pull the power cord.</p> <ul style="list-style-type: none"> This may cause a portion of the core wire to break, which may cause overheating or fire.
	<p>Do not charge or disassemble the batteries, and do not throw them into a fire.</p> <ul style="list-style-type: none"> This may cause the batteries to leak, or cause a fire or explosion.
	<p>Do not operate the unit for more than 4 hours at high humidity (80% RH or more) and/or with windows or outside door left open.</p> <ul style="list-style-type: none"> This may cause the water condensation in the air conditioner, which may drip down, wetting or damaging the furniture. The water condensation in the air conditioner may contribute to growth of fungi, such as mold.
	<p>Do not use the unit for special purposes, such as storing food, raising animals, growing plants, or preserving precision devices or art objects.</p> <ul style="list-style-type: none"> This may cause deterioration of quality, or harm to animals and plants.
	<p>Do not expose combustion appliances to direct airflow.</p> <ul style="list-style-type: none"> This may cause incomplete combustion.
	<p>Never put batteries in your mouth for any reason to avoid accidental ingestion.</p> <ul style="list-style-type: none"> Battery ingestion may cause choking and/or poisoning.





	<p>Before cleaning the unit, switch it OFF and disconnect the power plug or turn the breaker OFF.</p> <ul style="list-style-type: none"> This may cause injury, since the fan inside rotates at high speeds during operation.
	<p>When the unit will be unused for a long time, disconnect the power plug or turn the breaker OFF.</p> <ul style="list-style-type: none"> The unit may accumulate dirt, which may cause overheating or fire.
	<p>Replace all batteries of the remote controller with new ones of the same type.</p> <ul style="list-style-type: none"> Using an old battery together with a new one may cause overheating, leakage, or explosion.
	<p>If the battery fluid comes in contact with your skin or clothes, wash them thoroughly with clean water.</p> <ul style="list-style-type: none"> If the battery fluid comes in contact with your eyes, wash them thoroughly with clean water and immediately seek medical attention.
	<p>Ensure that the area is well-ventilated when the unit is operated together with a combustion appliance.</p> <ul style="list-style-type: none"> Inadequate ventilation may cause oxygen starvation.
	<p>Do not operate the air conditioner after applying protecting agent on the floor.</p> <ul style="list-style-type: none"> Components in the protecting agent may attach the inside of the indoor unit, resulting leakage or splattering of dew.
	<p>Turn the breaker OFF when you hear thunder and there is a possibility of a lightning strike.</p> <ul style="list-style-type: none"> The unit may be damaged if lightning strikes.
	<p>After the air conditioner is used for several seasons, perform inspection and maintenance in addition to normal cleaning.</p> <ul style="list-style-type: none"> Dirt or dust in the unit may create an unpleasant odor, contribute to growth of fungi, such as mold, or clog the drain passage, and cause water to leak from the indoor unit. Consult your dealer for inspection and maintenance, which require specialized knowledge and skills.
	<p>Do not operate switches with wet hands.</p> <ul style="list-style-type: none"> This may cause electric shock.
	<p>Do not clean the air conditioner with water or place an object that contains water, such as a flower vase, on it.</p> <ul style="list-style-type: none"> This may cause fire or electric shock.
	<p>Do not step on or place any object on the outdoor unit.</p> <ul style="list-style-type: none"> This may cause injury if you or the object falls down.

IMPORTANT







<p>Dirty filters cause condensation in the air conditioner which will contribute to the growth of fungi such as mold. It is therefore recommended to clean air filters every 2 weeks.</p>
<p>Before starting the operation, ensure that the horizontal vanes are in the closed position. If operation starts when the horizontal vanes are in the open position, they may not return to the correct position.</p>

SAFETY PRECAUTIONS

For installation

 WARNING	
	<p>Consult your dealer for installing the air conditioner.</p> <ul style="list-style-type: none"> It should not be installed by the user since installation requires specialized knowledge and skills. An improperly installed air conditioner may cause water leakage, fire, or electric shock.
	<p>Provide a dedicated power supply for the air conditioner.</p> <ul style="list-style-type: none"> A non-dedicated power supply may cause overheating or fire.
	<p>Do not install the unit where flammable gas could leak.</p> <ul style="list-style-type: none"> If gas leaks and accumulates around the outdoor unit, it may cause an explosion.
	<p>Earth the unit correctly.</p> <ul style="list-style-type: none"> Do not connect the earth wire to a gas pipe, water pipe, lightning rod, or a telephone earth wire. Improper earthing may cause electric shock.
 CAUTION	
	<p>Install an earth leakage breaker depending on the installation location of the air conditioner (such as highly humid areas).</p> <ul style="list-style-type: none"> If an earth leakage breaker is not installed, it may cause electric shock.
	<p>Ensure that the drain water is properly drained.</p> <ul style="list-style-type: none"> If the drain passage is improper, water may drip down from the indoor/outdoor unit, wetting and damaging the furniture.
<p>In case of an abnormal condition Immediately stop operating the air conditioner and consult your dealer.</p>	

For Wi-Fi interface

 WARNING	
(Improper handling may have serious consequences, including serious injury or death.)	
	<p>This appliance can be used by children aged from 8 years and above and persons with reduced physical, sensory or mental capabilities or lack of experience and knowledge if they have been given supervision or instruction concerning use of the appliance in a safe way and understand the hazards involved.</p> <p>Children shall not play with the appliance. Cleaning and user maintenance shall not be made by children without supervision.</p> <p>Do not use the Wi-Fi interface nearby the medical electrical equipment or people who have a medical device such as a cardiac pacemaker or an implantable cardioverter-defibrillator.</p> <ul style="list-style-type: none"> It can cause an accident due to malfunctions of the medical equipment or device.
	<p>Do not install the Wi-Fi interface nearby the automatic control devices such as automatic doors or fire alarms.</p> <ul style="list-style-type: none"> It can cause accidents due to malfunctions.
	<p>Do not touch the Wi-Fi interface with wet hands.</p> <ul style="list-style-type: none"> It can cause damage to the device, electric shock, or fire.
	<p>Do not splash water on the Wi-Fi interface or use it in a bathroom.</p> <ul style="list-style-type: none"> It can cause damage to the device, electric shock, or fire.
	<p>When the Wi-Fi interface is dropped, or the holder or cable is damaged, disconnect the power supply plug or turn the breaker OFF.</p> <ul style="list-style-type: none"> It may cause fire or electric shock. In this case, consult your dealer.
 CAUTION	
(Improper handling may have consequences, including injury or damage to building.)	
	<p>Do not step on unstable stepstool to set up or clean the Wi-Fi interface.</p> <ul style="list-style-type: none"> It may cause injury if you fall down.
	<p>Do not use the Wi-Fi interface nearby other wireless devices, micro-waves, cordless phones, or facsimiles.</p> <ul style="list-style-type: none"> It can cause malfunctions.

EN

DISPOSAL



Fig. 1

When batteries are included;
 • To dispose of this product, consult your dealer.

Note:

This symbol mark is for EU countries only.
 This symbol mark is according to the directive 2012/19/EU Article 14 Information for users and Annex IX, and/or to the regulation (EU) 2023/1542 Article 74 Information for end-users and Annex VI.

Your MITSUBISHI ELECTRIC product is designed and manufactured with high quality materials and components which can be recycled and/or reused. This symbol means that electrical and electronic equipment, batteries and accumulators, at their end-of-life, should be disposed of separately from your household waste.

If a chemical symbol is printed beneath the symbol (Fig. 1), this chemical symbol means that the battery or accumulator contains a heavy metal at a certain concentration. This will be indicated as follows:
 Hg: mercury (0.0005%), Cd: cadmium (0.002%), Pb: lead (0.004%)

In the European Union there are separate collection systems for used electrical and electronic products, batteries and accumulators. Please, dispose of this equipment, batteries and accumulators correctly at your local community waste collection/recycling centre. Please, help us to conserve the environment we live in!

NAME OF EACH PART

Indoor unit

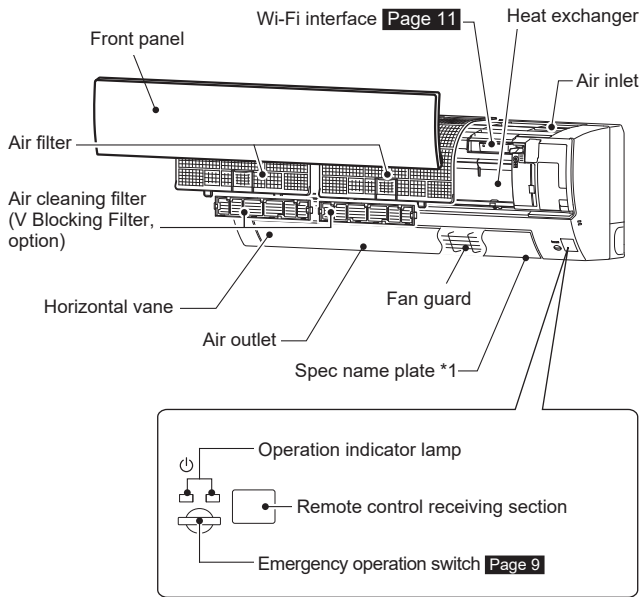

Outdoor unit

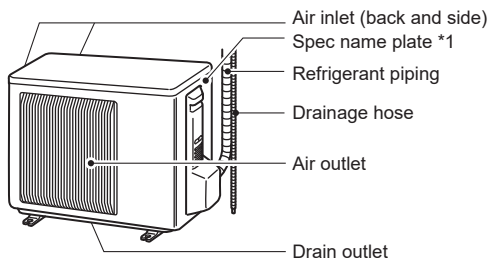

Outdoor units may be different in appearance.

*1 The manufacturing year and month are indicated on the spec name plate.

Remote controller

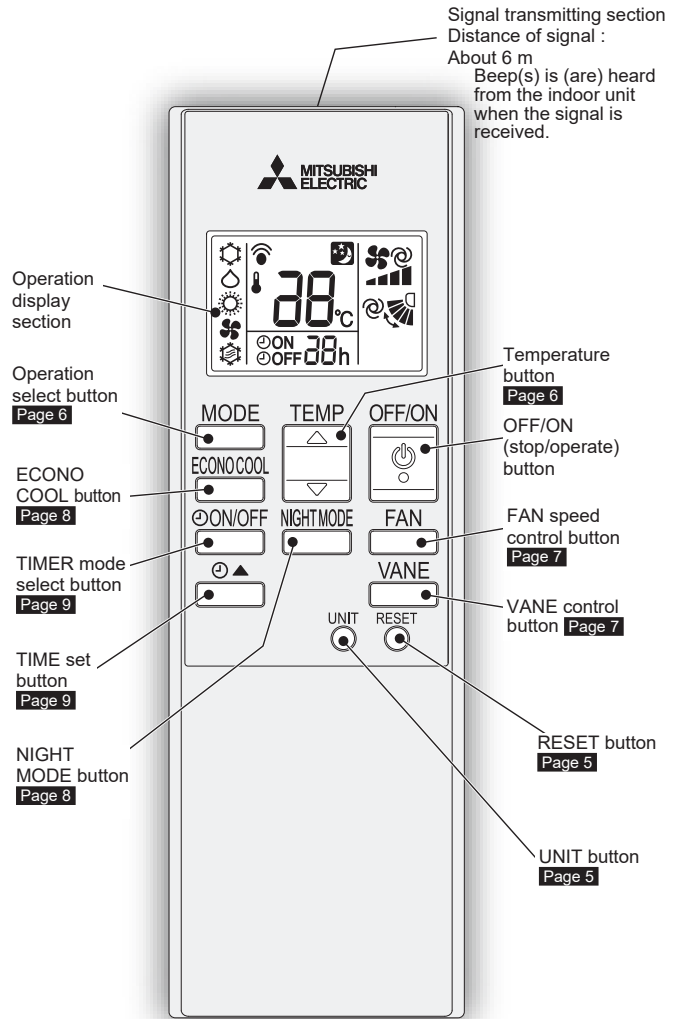

Only use the remote controller provided with the unit.
Do not use other remote controllers.
If two or more indoor units are installed in proximity to one another, an indoor unit that is not intended to be operated may respond to the remote controller.

Remote controller

When the remote controller is not used, place it near this unit.

PREPARATION BEFORE OPERATION

Before operation: Insert the power supply plug into the power outlet and/or turn the breaker on.

Installing the remote controller batteries

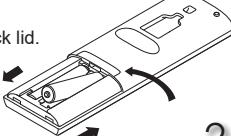
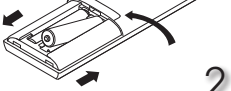
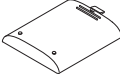
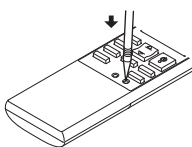
1. Remove the back lid. 
2. Insert the negative pole of AAA alkaline batteries first. 
3. Install the back lid. 
4. Press RESET. 

EN

Note:

- Make sure the polarity of the batteries is correct.
- Do not use manganese batteries and leaking batteries. The remote controller could malfunction.
- Do not use rechargeable batteries.
- Replace all batteries with new ones of the same type.
- Batteries can be used for approximately 1 year. However, batteries with expired shelf lives last shorter.
- Press RESET gently using a thin instrument.
If the RESET is not pressed, the remote controller may not operate correctly.

Note:

How to set remote controller exclusively for a particular indoor unit

A maximum of 4 indoor units with wireless remote controllers can be set.

To operate the indoor unit individually with each remote controller, assign a number to each remote controller according to the number of the indoor unit. Please set according to the following procedure:

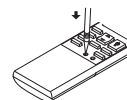

- (1) Turn the breaker OFF for the unit.
- (2) With the remote controller powered OFF, hold down UNIT on the remote controller for 2 seconds to enter the pairing mode. Setting number is displayed in the remote controller.
- (3) Press UNIT again and assign a number to each remote controller. Each press of UNIT advances the number in the following order: 1→2→3→4.
- (4) Press **MODE** to complete the pairing setting.





After you turn the breaker ON, the remote controller that first sends a signal to an indoor unit will be regarded as the remote controller for the indoor unit.

Once they are set, the indoor unit will only receive the signal from the assigned remote controller afterwards.

The setting of indoor unit will be cancelled, if the breaker is turned OFF or the power supply is shut down.

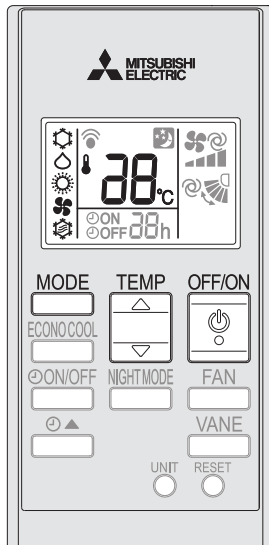

SELECTING OPERATION MODES



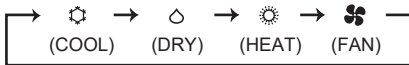

1 Press  to start the operation.

2 Press  to select operation mode. Each press changes mode in the following order:



3 Press  or  to set the temperature. Each press raises or lowers the temperature by 1°C.

Press  to stop the operation.

• The same setting is selected the next time by simply pressing .

COOL mode

Enjoy cool air at your desired temperature.

Note:

Do not operate COOL mode at very low outside temperatures (less than -10°C). Water condensed in the unit may drip and wet or damage furniture, etc.

DRY mode

Dehumidify your room. The room may be cooled slightly. Temperature cannot be set during DRY mode.

HEAT mode

Enjoy warm air at your desired temperature.

FAN mode

Circulate the air in your room.

Note:

After COOL/DRY mode operation, it is recommended to operate in the FAN mode to dry inside the indoor unit.



Note:

Multi system operation

Two or more indoor units can be operated by one outdoor unit. When several indoor units are operated simultaneously, cooling/dry/fan and heating operations cannot be done at the same time. When COOL/DRY/FAN is selected with one unit and HEAT with another or vice versa, the unit selected last goes into standby mode.

Operation indicator lamp

The operation indicator lamp shows the operation state of the unit.

Indication	Operation state	Room temperature
	The unit is operating to reach the set temperature	About 2°C or more away from set temperature
	The room temperature is approaching the set temperature	About 1 to 2°C from set temperature
	Standby mode (only during multi system operation)	—

 Lit  Blinking  Not lit

FAN SPEED AND AIRFLOW DIRECTION ADJUSTMENT

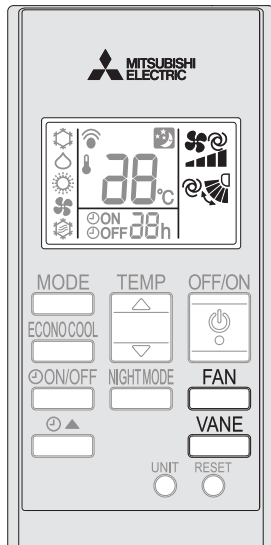

Fan speed

1 Press **FAN** to select fan speed. Each press changes fan speed in the following order:



- Two short beeps are heard from the indoor unit when set to AUTO.
- Use higher fan speed to cool/heat the room quicker. It is recommended to lower the fan speed once the room is cool/warm.
- Use lower fan speed for quiet operation.

Note:

Multi system operation

When several indoor units are operated simultaneously by one outdoor unit for heating operation, the temperature of the airflow may be low. In this case, it is recommended to set the fan speed to AUTO.

Up-down Airflow direction

1 Press **VANE** to select airflow direction. Each press changes airflow direction in the following order:

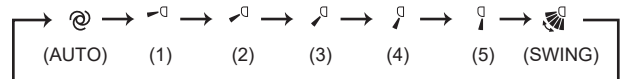

- ⊙ (AUTO).....The vane is set to the most efficient airflow direction. COOL/ DRY/FAN: horizontal position. HEAT: position (4).
- ☂ (Manual).....For efficient air conditioning, select the upper position for COOL/DRY, and the lower position for HEAT. If the lower position is selected during COOL/DRY, the vane automatically moves to the upward position after 0.5 to 1 hour to prevent any condensation from dripping.
- ☂ (Swing).....The vane moves up and down intermittently.
 - Two short beeps are heard from the indoor unit when set to AUTO.

Left-right Airflow direction

■ To change the horizontal airflow direction.

Move the vertical vane manually before starting operation.

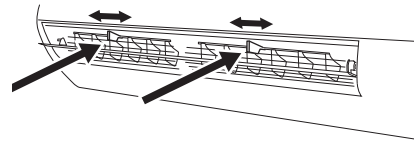

Note:

If the vertical vanes are adjusted while the unit is not operating, be sure to return the horizontal vanes to the original closed position.

ECONO COOL OPERATION

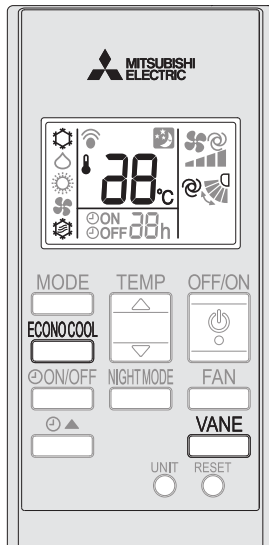

Swing airflow (change of airflow) makes you feel cooler than stationary airflow. The set temperature and the airflow direction are automatically changed by the microprocessor. It is possible to perform cooling operation with keeping comfort. As a result energy can be saved.

1 Press  during COOL mode [page 6](#) to start ECONO COOL operation.

The unit performs swing operation vertically in various cycle according to the temperature of the unit. Set temperature is set 2°C higher automatically.

Press  again to cancel ECONO COOL operation.

- Pressing  also cancels ECONO COOL operation.

NIGHT MODE OPERATION

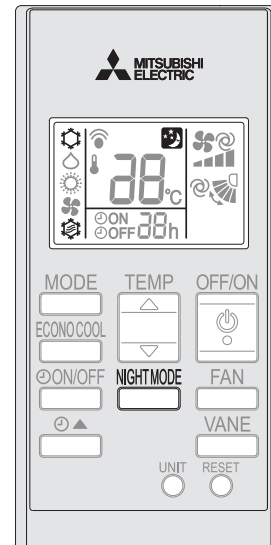

NIGHT MODE operation changes the brightness of the operation indicator, disables the beep sound and limits the noise level of the outdoor unit.

1 Press  during operation to activate NIGHT MODE operation.

- The operation indicator lamp dims.
- The beep sound will be disabled except that emitted when the operation is started or stopped.
- Noise level of the outdoor unit will be lower than that mentioned in the specifications.

Press  again to cancel NIGHT MODE operation.

Note:

- The cooling/heating capacity may drop.
- Noise level of the outdoor unit may not change after start-up of the unit, during the protection operation, or depending on other operating conditions.
- The fan speed of the indoor unit will not change.
- The operation indicator lamp will be hard to be seen in a bright room.
- Noise level of the outdoor unit will not decrease during Multi system operation.

TIMER OPERATION (ON/OFF TIMER)

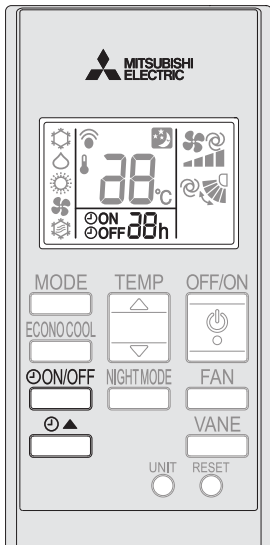

EN

- 1** Press  during operation to set the timer. Each press changes timer mode in the following order:



- 2** Press  to set the time of timer. Each press increases or decreases the set time by 1 hour.

Press  until "TIMER RELEASE" is selected to release timer.

Note:

- ON and OFF timers can not be used in combination.
- If power failure occurs while ON/OFF timer is set, see [page 9](#) "Auto restart function".

EMERGENCY OPERATION

When the remote controller cannot be used...

Emergency operation can be activated by pressing the emergency operation switch (E.O. SW) on the indoor unit.

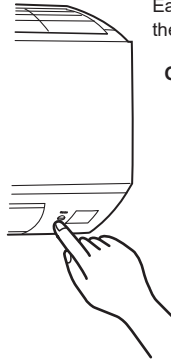

Each time the E.O. SW is pressed, the operation changes in the following order:

Operation indicator lamp

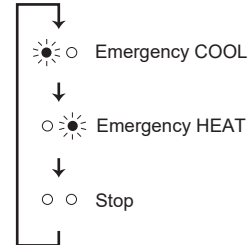

Set temperature : 24°C
Fan speed : Medium
Horizontal vane : Auto

Note:

- The first 30 minutes of operation is test run. Temperature control does not work, and fan speed is set to High.
- In the emergency heating operation, the fan speed gradually rises to blow out warm air.

AUTO RESTART FUNCTION

If a power failure occurs or the main power is turned off during operation, "Auto restart function" automatically starts operation in the same mode as the one set with the remote controller just before the shutoff of the main power. When timer is set, timer setting is cancelled and the unit starts operation when power is resumed.

If you do not want to use this function, please consult the service representative because the setting of the unit needs to be changed.

CLEANING

Instructions:

- Switch off the power supply or turn off the breaker before cleaning.
- Be careful not to touch the metal parts with your hands.
- Do not use benzene, thinner, polishing powder, or insecticide.
- When dirt stands out, wash it with kitchen neutral detergent diluted with lukewarm water to the specified concentration, then wipe off the detergent with a damp towel.
- Do not use a scrubbing brush, a hard sponge, or the like.
- Do not soak or rinse the horizontal vane.
- Do not use water hotter than 50°C.
- Do not expose parts to direct sunlight, heat, or fire to dry.
- Do not apply excessive force on the fan as it may cause cracks or breakage.

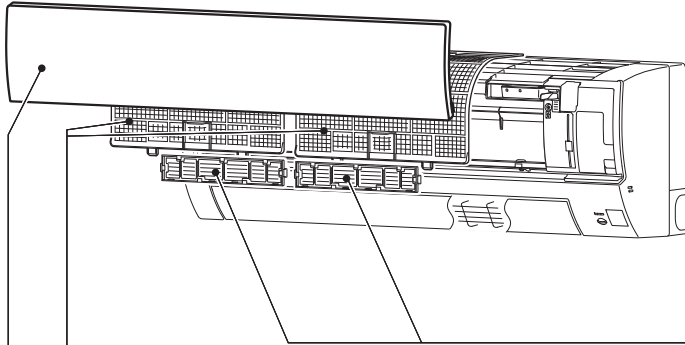

Air filter (Air purifying filter)

When it's time for filter cleaning

The operation indicator lamp blinks when operation starts and stops, which means that the filter needs to be cleaned.

- Remove dirt by a vacuum cleaner, or rinse with water.
- After washing with water, dry it well in shade.

After filter cleaning

To reset the blinking of operation indicator lamp, turn the breaker on and operate a remote controller as follows.

- Press and hold  until the indoor unit beeps while the remote controller is OFF.

Air cleaning filter (V Blocking Filter, option)

Every 3 months:

- Remove dirt by a vacuum cleaner.

When dirt cannot be removed by vacuum cleaning:

- Soak the filter and its frame in lukewarm water before rinsing it.
- After washing, dry it well in shade. Install all tabs of the air filter.

Every year:

- Replace it with a new air cleaning filter for best performance.
- Parts Number **MAC-2470FT-E**

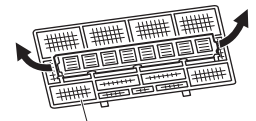

Pull to remove from the air filter

Front panel

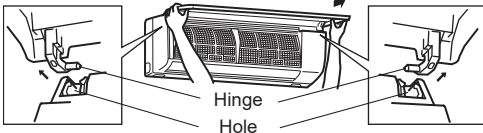

1. Lift the front panel until a "click" is heard.
2. Hold the hinges and pull to remove as shown in the illustration above.
 - Wipe with a soft dry cloth or rinse it with water.
 - Do not soak it in water for more than two hours.
 - Dry it well in shade before installing it.
3. Install the front panel by following the removal procedure in reverse. Close the front panel securely and press the positions indicated by the arrows.



! Important

- **Clean the filters regularly for best performance and to reduce power consumption.**
- **Dirty filters cause condensation in the air conditioner which will contribute to the growth of fungi such as mold. It is therefore recommended to clean air filters every 2 weeks.**

This information is based on **REGULATION (EU) No 528/2012**

MODEL NAME	Treated Article (Parts name)	Active Substances (CAS No.)	Property	Instruction for Use (Safe handling information)
MSZ-HR25/35/42/50VF(K)2	FILTER	Silver sodium hydrogen zirconium phosphate (265647-11-8) 2-octyl-2H-isothiazol-3-one (OIT) (26530-20-1)	Antibacterial Antimold	<ul style="list-style-type: none"> • Use this product in line with the instruction manual indications and for the intended purpose only. • Do not put into mouth. Keep away from children.
MAC-2470FT-E	FILTER	Dimethyloctadecyl[3-(trimethoxysilyl)propyl]ammonium chloride (27668-52-6)	Antivirus Antibacterial Antimold	<ul style="list-style-type: none"> • Use this product in line with the instruction manual indications and for the intended purpose only. • Do not put into mouth. Keep away from children.

Wi-Fi INTERFACE SETTING UP (VFK type only)

This Wi-Fi interface, communicates the status information and controls the commands from the MELCloud by connecting to the indoor unit.

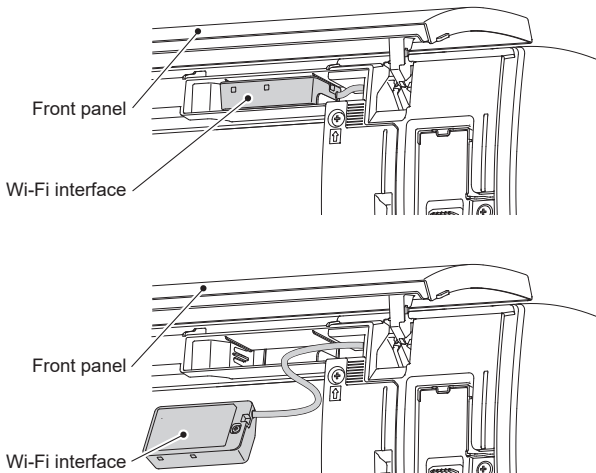

In addition, check the following.

- Make sure that the communication distance is not too far between the Wi-Fi interface and the Router.
- Make sure that the Router uses WPA2-AES encryption.
- Make sure that the number of connected devices to the Router does not exceed the limit.
- Set up the Wi-Fi interface after operating the air conditioner using the wireless remote controller at least once.

If the connection fails even after checking the above, set up the Wi-Fi interface and the router again by the following method.

To reset connection and set up the Wi-Fi interface and the router again

- Hold down the Temperature \ominus for 5 seconds.
- Select “_ 2” by pressing Temperature \oplus and \ominus .
- Point the remote controller toward the indoor unit and press the OFF/ON .
- The indoor unit beeps 3 times when resetting is complete.

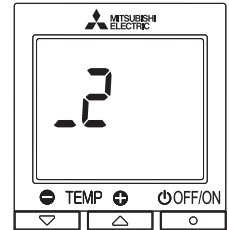

EN

Setting Up

- Download the MELCloud application. Please go to the website below.
<https://www.melcloud.com/?qr=1>



When It Doesn't Connect Well



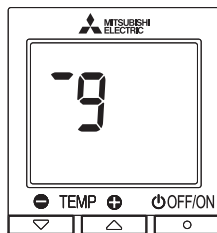

Troubleshooting mode

- Hold down the Temperature \oplus for 5 seconds.
- Select “_ 9” by pressing Temperature \oplus and \ominus as shown on the right.
- Point the remote controller toward the indoor unit and press the OFF/ON .

Troubleshooting mode

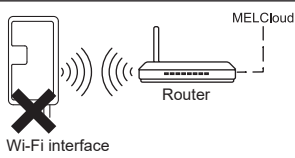

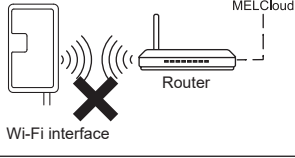
In the troubleshooting mode, you can check what kind of error is occurring by the blinking pattern of the indoor unit operation indicator lamp as follows.

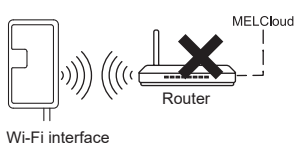
Indication	Description	Check point
○  10 times	 Wi-Fi interface	Check the connection between unit and Wi-Fi interface.
○  5 times	 Wi-Fi interface	Make sure that DHCP is enabled. or check IP address settings of the Wi-Fi interface.
○  7 times	 Wi-Fi interface	Check if the Router is connected to the internet. or check DNS setting the Router and Wi-Fi interface.

[About trademarks]

- “Wi-Fi”, “Wi-Fi Protected Setup™”, “WPA2™” are trademarks or registered trademarks of the Wi-Fi Alliance. The Wi-Fi Interface uses Open Source Software.
- The Bluetooth® word mark is registered trademarks owned by Bluetooth SIG, Inc.

Note:

- Ensure that the Router supports the WPA2-AES encryption setting and 2.4GHz before commencement of the installation of this Wi-Fi interface.
- The end user should read and accept the terms and conditions of the Wi-Fi service before using this Wi-Fi interface.
- To complete connection of this Wi-Fi interface to the Wi-Fi service, the Router may be required.
- This Wi-Fi interface will not commence transmission of any operational data from the system until the end user registers and accepts the terms and conditions of the Wi-Fi service.
- Do not place the Wi-Fi interface where it can be easily accessed by third parties.
- This Wi-Fi interface should not be installed and connected to any Mitsubishi Electric system which is to provide application critical cooling or heating.
- Please write down the information regarding the Wi-Fi interface setting on the last page of this manual, when you set up this Wi-Fi interface.
- At the time of relocation or disposal, reset the Wi-Fi interface to the factory default.
- To fully connect this Wi-Fi interface to the Wi-Fi service, you may need a router and a smartphone compatible with Bluetooth® Low Energy 4.2 or later.

Mitsubishi Electric's Wi-Fi interface is designed for communication to Mitsubishi Electric's MELCloud Wi-Fi service. Mitsubishi Electric is not responsible for any (i) underperformance of a system or any product; (ii) system or product fault; or (iii) loss or damage to any system or product; which is caused by or arises from connection to and/or use of any third party Wi-Fi interface or any third party Wi-Fi service with Mitsubishi Electric equipment.

For the latest information regarding MELCloud from Mitsubishi Electric Corporation, please visit www.melcloud.com.

WHEN YOU THINK THAT TROUBLE HAS OCCURRED

Even if these items are checked, when the unit does not recover from the trouble, stop using the air conditioner and consult your dealer.

Symptom	Explanation & Check points
Indoor Unit	
The unit cannot be operated.	<ul style="list-style-type: none"> Is the breaker turned on? Is the power supply plug connected? Is the ON timer set? Page 9
The horizontal vane does not move.	<ul style="list-style-type: none"> Are the horizontal vane and the vertical vane installed correctly? Is the fan guard deformed?
The unit cannot be operated for about 3 minutes when restarted.	<ul style="list-style-type: none"> This protects the unit according to instructions from the microprocessor. Please wait.
Mist is discharged from the air outlet of the indoor unit.	<ul style="list-style-type: none"> The cool air from the unit rapidly cools moisture in the air inside the room, and it turns into mist.
The swing operation of the HORIZONTAL VANE is suspended for a while, then restarted.	<ul style="list-style-type: none"> This is for the swing operation of the HORIZONTAL VANE to be performed normally.
The airflow direction changes during operation. The direction of the horizontal vane cannot be adjusted with the remote controller.	<ul style="list-style-type: none"> When the unit is operated in COOL or DRY mode, if the operation continues with air blowing down for 0.5 to 1 hour, the direction of the airflow is automatically set to upward position to prevent water from condensing and dripping. In the heating operation, if the airflow temperature is too low or when defrosting is being done, the horizontal vane is automatically set to horizontal position.
The operation stops for about 10 minutes in the heating operation.	<ul style="list-style-type: none"> Outdoor unit is in defrost. Since this is completed in max. 10 minutes, please wait. (When the outside temperature is too low and humidity is too high, frost is formed.)
The unit starts operation by itself when the main power is turned on, but hasn't received sign from the remote controller.	<ul style="list-style-type: none"> These models are equipped with an auto restart function. When the main power is turned off without stopping the unit with the remote controller and is turned on again, the unit starts operation automatically in the same mode as the one set with the remote controller just before the shutoff of the main power. Refer to "Auto restart function". Page 9
In COOL/DRY mode, when the room temperature reaches near the set temperature, the outdoor unit stops, then the indoor unit operates at low speed.	<ul style="list-style-type: none"> When the room temperature deviates from the set temperature, the indoor fan starts running according to the settings on the remote controller.
The indoor unit discolors over time.	<ul style="list-style-type: none"> Although plastic turns yellow due to the influence of some factors such as ultraviolet light and temperature, this has no effect on the product functions.
The operation indicator lamp is dim. The unit does not beep.	<ul style="list-style-type: none"> Is the NIGHT MODE operation set? Page 8
Multi system	
The indoor unit which is not operating becomes warm and a sound, similar to water flowing, is heard from the unit.	<ul style="list-style-type: none"> A small amount of refrigerant continues to flow into the indoor unit even though it is not operating.
When heating operation is selected, operation does not start right away.	<ul style="list-style-type: none"> When operation is started during defrosting of outdoor unit is done, it takes a few minutes (max. 10 minutes) to blow out warm air.
Outdoor Unit	
The fan of the outdoor unit does not rotate even though the compressor is running. Even if the fan starts to rotate, it stops soon.	<ul style="list-style-type: none"> When the outside temperature is low during cooling operation, the fan operates intermittently to maintain sufficient cooling capacity.
Water leaks from the outdoor unit.	<ul style="list-style-type: none"> During COOL and DRY operations, pipe or pipe connecting sections are cooled and this causes water to condense. In the heating operation, water condensed on the heat exchanger drips down. In the heating operation, the defrosting operation makes ice forming on the outdoor unit melt and drip down.
White smoke is discharged from the outdoor unit.	<ul style="list-style-type: none"> In the heating operation, vapor generated by the defrosting operation looks like white smoke.
Remote controller	
The display on the remote controller does not appear or it is dim. The indoor unit does not respond to the remote control signal.	<ul style="list-style-type: none"> Are the batteries exhausted? Page 5 Is the polarity (+, -) of the batteries correct? Page 5 Are any buttons on the remote controller of other electric appliances being pressed?

Symptom	Explanation & Check points
Does not cool or heat	
The room cannot be cooled or heated sufficiently.	<ul style="list-style-type: none"> Is the temperature setting appropriate? Page 6 Is the fan setting appropriate? Please change fan speed to High or Super High. Page 7 Are the filters clean? Page 10 Is the fan or heat exchanger of the indoor unit clean? Page 10 Are there any obstacles blocking the air inlet or outlet of the indoor or outdoor unit? Is a window or door open? It may take a certain time to reach the setting temperature or may not reach that depending on the size of the room, the ambient temperature, and the like. Is the NIGHT MODE operation set? Page 8
The room cannot be cooled sufficiently.	<ul style="list-style-type: none"> When a ventilation fan or a gas cooker is used in a room, the cooling load increases, resulting in an insufficient cooling effect. When the outside temperature is high, the cooling effect may not be sufficient.
The room cannot be heated sufficiently.	<ul style="list-style-type: none"> When the outside temperature is low, the heating effect may not be sufficient.
Air does not blow out soon in the heating operation.	<ul style="list-style-type: none"> Please wait as the unit is preparing to blow out warm air.
Airflow	
The air from the indoor unit smells strange.	<ul style="list-style-type: none"> Are the filters clean? Page 10 Is the fan or heat exchanger of the indoor unit clean? Page 10 The unit may suck in an odor adhering to the wall, carpet, furniture, cloth, etc. and blow it out with the air.
Sound	
Cracking sound is heard.	<ul style="list-style-type: none"> This sound is generated by the expansion/contraction of the front panel, etc. due to change in temperature.
"Bubbling" sound is heard.	<ul style="list-style-type: none"> This sound is heard when the outside air is absorbed from the drain hose by turning on the range hood or the ventilation fan, making water flowing in the drain hose to spout out. This sound is also heard when the outside air blows into the drain hose in case the outside wind is strong.
Mechanical sound is heard from the indoor unit.	<ul style="list-style-type: none"> This is the switching sound in turning on/off the fan or the compressor.
The sound of water flowing is heard.	<ul style="list-style-type: none"> This is the sound of refrigerant or condensed water flowing in the unit.
Hissing sound is sometimes heard.	<ul style="list-style-type: none"> This is the sound when the flow of refrigerant inside the unit is changed.
Wi-Fi interface	
When error occurs during connection setup or operation.	<p>Refer to the SETUP MANUAL. For SETUP MANUAL, please go to the website below. https://www.melcloud.com/Support</p>

In the following cases, stop using the air conditioner and consult your dealer.

- When water leaks or drips from the indoor unit.
- When the operation indicator lamp blinks.
- When the breaker trips frequently.
- The remote control signal is not received in a room where an electronic ON/OFF type fluorescent lamp (inverter-type fluorescent lamp, etc.) is used.
- Operation of the air conditioner interferes with radio or TV reception. An amplifier may be required for the affected device.
- When an abnormal sound is heard.
- When any refrigerant leakage is found.

EN

WHEN THE AIR CONDITIONER IS NOT GOING TO BE USED FOR A LONG TIME

- 1 Operate by COOL mode with the highest temperature set or FAN mode for 3 to 4 hours. **Page 6**
 - This dries the inside of the unit.
 - Moisture in the air conditioner contributes to favorable conditions for growth of fungi, such as mold.
- 2 Press  to stop the operation.
- 3 Turn off the breaker and/or disconnect the power supply plug.
- 4 Remove all batteries from the remote controller.

EN

When using the air conditioner again:

- 1 Clean the air filter. **Page 10**
- 2 Check that the air inlet and outlet of the indoor and outdoor units are not blocked.
- 3 Check that the earth is connected correctly.
- 4 Refer to the "PREPARATION BEFORE OPERATION", and follow the instructions. **Page 5**

INSTALLATION PLACE AND ELECTRICAL WORK

Installation place

Avoid installing the air conditioner in the following places.

- Where there is much machine oil.
- Salty places such as the seaside.
- Where sulfide gas is generated such as hot spring, sewage, waste water.
- Where oil is splashed or where the area is filled with oily smoke (such as cooking areas and factories, in which the properties of plastic could be changed and damaged).
- Where there is high-frequency or wireless equipment.
- Where the air from the outdoor unit air outlet is blocked.
- Where the operation sound or air from the outdoor unit bothers the house next door.
- The mounting height of indoor unit 1.8 m to 2.3 m is recommended. If it is impossible, please consult your dealer.
- Do not operate the air conditioner during interior construction and finishing work, or while waxing the floor. Before operating the air conditioner, ventilate the room well after such work is performed. Otherwise, it may cause volatile elements to adhere inside the air conditioner, resulting in water leakage or scattering of dew.
- This equipment should be installed and operated with a minimum distance of 20 cm between the device and the user or bystanders.
- The indoor unit must be installed in rooms which exceed the floor space specified. Please consult your dealer.

For Wi-Fi interface

- This equipment should be installed and operated with a minimum distance of 20 cm between the device and the user or bystanders.
- Do not use the Wi-Fi interface nearby other wireless devices, microwaves, cordless phones, or facsimiles. It can cause malfunctions.
- Do not use the Wi-Fi interface nearby the medical electrical equipment or people who have a medical device such as a cardiac pacemaker or an implantable cardioverter-defibrillator. It can cause an accident due to malfunctions of the medical equipment or device.

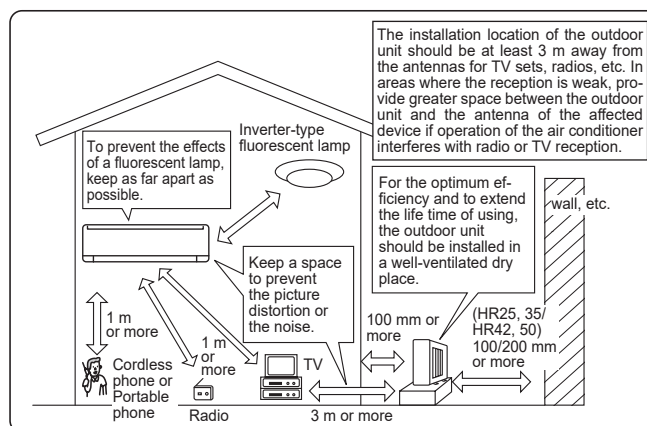

Electrical work

- Provide an exclusive circuit for the power supply of the air conditioner.
- Be sure to observe the breaker capacity.

If you have any questions, consult your dealer.

SPECIFICATIONS

Model	Indoor		MSZ-HR25VF(K)2		MSZ-HR35VF(K)2		MSZ-HR42VF(K)2		MSZ-HR50VF(K)2	
	Outdoor		MUZ-HR25VF2		MUZ-HR35VF2		MUZ-HR42VF2		MUZ-HR50VF2	
Function			❄️ Cooling	🔥 Heating	❄️ Cooling	🔥 Heating	❄️ Cooling	🔥 Heating	❄️ Cooling	🔥 Heating
Power supply			~ /N, 230 V, 50 Hz							
Capacity	kW		2.5	3.15	3.4	3.6	4.2	4.7	5.0	5.4
Input	kW		0.80	0.85	1.21	1.00	1.36	1.30	2.05	1.55
Weight	Indoor	kg	8.5				9			
	Outdoor	kg	21.5		22.0 *1		32.5 *1		33.5 *1	
Refrigerant filling capacity (R32)	kg		0.38		0.42		0.70		0.80	
IP code	Indoor						IPX0			
	Outdoor						IPX4			
Permissible excessive operating pressure	LP ps	MPa					2.77			
	HP ps	MPa					4.17			
Noise level (SPL)	Indoor (Super High/High/Med./Low)	dB(A)	43/37/30/21	43/37/30/21	46/38/31/22	44/37/30/21	45/39/34/24	46/40/32/24	45/40/36/28	47/41/34/27
	Outdoor	dB(A)	50	50	51	51	50	51	50	51

*1 Refer to the spec name plate for the unit weight.

Deutsch

Modell	Innengerät	Außengerät
Funktion		
Netzanschluss		
Leistung	kW	
Eingang	kW	
Gewicht	Innengerät	kg
	Außengerät	kg
Kältemittelfüllung (R32)	kg	
IP-Code	Innengerät	
	Außengerät	
Zulässiger Betriebsüberdruck	LP ps	MPa
	HP ps	MPa
Geräuschpegel (SPL)	Innengerät (Sehr Hoch/Hoch/Mittel/Niedrig)	dB(A)
	Außengerät	dB(A)

Français

Modèle	Interne	Externe
Fonction		
Alimentation		
Puissance	kW	
Entrée	kW	
Poids	Interne	kg
	Externe	kg
Capacité de remplissage du réfrigérant (R32)	kg	
Code IP	Interne	
	Externe	
Pression de fonctionnement excessive autorisée	LP ps	MPa
	HP ps	MPa
Niveau sonore (SPL)	Interne (Très élevée/Elevé/Moyen/Faible)	dB(A)
	Externe	dB(A)

Nederlands

Model	Binnen	Buiten
Functie		
Stroomvoorziening		
Capaciteit	kW	
Invoer	kW	
Gewicht	Binnen	kg
	Buiten	kg
Hoeveelheid koelmiddel (R32)	kg	
IP-waarde	Binnen	
	Buiten	
Toelaatbare maximale bedrijfsdruk	Inlaatzijde	MPa
	Uitlaatzijde	MPa
Geluidsniveau (SPL)	Binnen (Superhoog/Hoog/Medium/Laag)	dB(A)
	Buiten	dB(A)

Español

Modelo	Interior	Exterior
Función		
Alimentación		
Capacidad	kW	
Entrada	kW	
Peso	Interior	kg
	Exterior	kg
Capacidad de depósito de refrigerante (R32)	kg	
Código IP	Interior	
	Exterior	
Exceso de presión de funcionamiento permisible	LP ps	MPa
	HP ps	MPa
Nivel de ruido (SPL)	Interior (Muy Alto/Alto/Medio/Bajo)	dB(A)
	Exterior	dB(A)

Italiano

Modello	Interno	Esterno
Funzione		
Alimentazione		
Capacità	kW	
Ingresso	kW	
Peso	Interno	kg
	Esterno	kg
Capacità fluido refrigerante (R32)	kg	
Codice IP	Interno	
	Esterno	
Eccesso di pressione di funzionamento consentito	LP ps	MPa
	HP ps	MPa
Livello di rumore (SPL)	Interno (Molto alto/Alto/Medio/Basso)	dB(A)
	Esterno	dB(A)

Ελληνικά

Μοντέλο	Εσωτερική	Εξωτερική
Λειτουργία		
Τροφοδοσία		
Απόδοση	kW	
Ισχύς εισόδου	kW	
Βάρος	Εσωτερική	kg
	Εξωτερική	kg
Χωρητικότητα πλήρωσης ψυκτικού (R32)	kg	
Κωδικός IP	Εσωτερική	
	Εξωτερική	
Μέγιστη επιτρεπόμενη πίεση λειτουργίας	LP ps	MPa
	HP ps	MPa
Επίπεδο θορύβου (SPL)	Εσωτερική (Πολύ υψηλή/Υψηλή/Μεσαία/Χαμηλή)	dB(A)
	Εξωτερική	dB(A)

Português

Modelo	Interior	Exterior
Função		
Alimentação elétrica		
Capacidade	kW	
Consumo	kW	
Peso	Interior	kg
	Exterior	kg
Capacidade de enchimento do refrigerante (R32)	kg	
Código IP	Interior	
	Exterior	
Pressão máxima admissível de funcionamento	PS de baixa pressão	MPa
	PS de alta pressão	MPa
Nível de ruído (SPL)	Interior (velocidade Muito Alta/Alta/Média/Baixa)	dB(A)
	Exterior	dB(A)

Dansk

Model	Indendørs	Udendørs
Funktion		
Strømforsyning		
Kapacitet	kW	
Indgang	kW	
Vægt	Indendørs	kg
	Udendørs	kg
Kølevæskekapacitet (R32)	kg	
IP-kode	Indendørs	
	Udendørs	
Tilladt overdriftstryk	LP ps	MPa
	HP ps	MPa
Støjniveau (SPL)	Indendørs (superhøj/høj/med./langsom)	dB(A)
	Udendørs	dB(A)

Svenska

Modell	Inomhus	Utomhus
Funktion		
Strömförsörjning		
Effekt	kW	
Ingång	kW	
Vikt	Inomhus	kg
	Utomhus	kg
Mängd köldmedium (R32)	kg	
IP-kod	Inomhus	
	Utomhus	
Tillåtet övertryck driftryck	LP ps	MPa
	HP ps	MPa
Ljudnivå (SPL)	Inomhus (Superhög/Hög/Med./Låg)	dB(A)
	Utomhus	dB(A)

SPECIFICATIONS

Български

Модел	Вътрешно тяло	Външно тяло
Функция		
Захранване		
Мощност		kW
Входяща мощност		kW
Тегло	Вътрешно	kg
	Външно	kg
Количество хладилен агент (R32)		kg
IP код	Вътрешно	
	Външно	
Допустимо работно налягане	LP ps	MPa
	HP ps	MPa
Шум (SPL)	Вътр. (Мн. висок/ Висок/Ср./Нисък)	dB(A)
	Външно	dB(A)

Suomi

Malli	Sisäyksikkö	Ulkoyksikkö
Toiminto		
Virtalähde		
Jäähdytys/lämmitysteho (nimellinen)		kW
Ottoteho (nimellinen)		kW
Paino	Sisäyksikkö	kg
	Ulkoyksikkö	kg
Kylmäaineen täyttökapasiteetti (R32)		kg
IP-luokka	Sisäyksikkö	
	Ulkoyksikkö	
Sallittu ylin käyttöpaino	LP ps	MPa
	HP ps	MPa
Melutaso (SPL)	Sisällä (erittäin korkea/korkea/normaali/matala)	dB(A)
	Ulkoyksikkö	dB(A)

Magyar

Modell	Beltéri egység	Kültéri egység
Funkció		
Tápellátás		
Kapacitás		kW
Teljesítményfelvétel		kW
Tömeg	Beltéri egység	kg
	Kültéri egység	kg
Hűtőközeg feltöltési mennyisége (R32)		kg
IP-kód	Beltéri egység	
	Kültéri egység	
Megengedett maximális üzemi nyomás	LP ps	MPa
	HP ps	MPa
Zajszint (SPL)	Beltéri egység (Nagyon magas/Magas/Köz./Alacs.)	dB(A)
	Kültéri egység	dB(A)

Polski

Model	Jednostka wewnętrzna	Jednostka zewnętrzna
Funkcja		
Zasilanie		
Moc		kW
Przełączanie		kW
Masa	Jednostka wewnętrzna	kg
	Jednostka zewnętrzna	kg
Ilość czynnika chłodniczego (R32)		kg
Stopień ochrony IP	Jednostka wewnętrzna	
	Jednostka zewnętrzna	
Dopuszczalne ciśnienie robocze	LP ps	MPa
	HP ps	MPa
Poziom hałasu (SPL)	Jednostka wewnętrzna (Super wys./Wys./Śred./Nis.)	dB(A)
	Jednostka zewnętrzna	dB(A)

Čeština

Model	Vnitřní	Vnější
Funkce		
Napájení		
Kapacita		kW
Vstup		kW
Hmotnost	Vnitřní	kg
	Vnější	kg
Náplň chladicího média (R32)		kg
Stupeň IP	Vnitřní	
	Vnější	
Přípustný nadměrný provozní tlak	Nízký tlak	MPa
	Vysoký tlak	MPa
Hlučnost (SPL)	Vnitřní (velmi vysoká / vysoká / střední / nízká rychlost)	dB(A)
	Vnější	dB(A)

Slovenščina

Model	Notranja enota	Zunanja enota
Funkcija		
Napajanje		
Jakost		kW
Vhod		kW
Teža	Notranja enota	kg
	Zunanja enota	kg
Količina hladilnega sredstva (R32)		kg
IP-koda	Notranja enota	
	Zunanja enota	
Dovoljen presežni delovni tlak	Nizek tlak	MPa
	Visok tlak	MPa
Raven hrupa (SPL)	Notranja enota (Zelo Visok/Visok/Srednji/Nizek)	dB(A)
	Zunanja enota	dB(A)

Norsk

Modell	Inne	Ute
Funksjon		
Strømforsyning		
Kapasitet		kW
Inngang		kW
Vekt	Inne	kg
	Ute	kg
Kjølemiddelkapasitet (R32)		kg
IP-kode	Inne	
	Ute	
Tillatt overtrykk under drift	LP ps	MPa
	HP ps	MPa
Støynivå (SPL)	Inne (Ekstra høy/Høy/Med./Lav)	dB(A)
	Ute	dB(A)

Slovenčina

Model	Interiérová jednotka	Exteriérová jednotka
Funkcia		
Napájanie		
Kapacita		kW
Vstup		kW
Hmotnosť	Interiérová jednotka	kg
	Exteriérová jednotka	kg
Plniaci objem chladiva (R32)		kg
Krytie IP	Interiérová jednotka	
	Exteriérová jednotka	
Pripustný nadmerný prevádzkový tlak	LP ps	MPa
	HP ps	MPa
Hladina hluku (SPL)	Int. (veľmi vys./vys./stred./níz.)	dB(A)
	Exteriérová jednotka	dB(A)

Română

Model	Interior	Exterior
Funcție		
Alimentare electrică		
Capacitate		kW
Intrare		kW
Greutate	Interior	kg
	Exterior	kg
Capacitatea de umplere cu agent frigorific (R32)		kg
Codul IP	Interior	
	Exterior	
Presiunea excesivă de funcționare permisă	LP ps	MPa
	HP ps	MPa
Nivelul de zgomot (SPL)	Interior (Super înalt/Înalt/Mediu/Scăzut)	dB(A)
	Exterior	dB(A)

SPECIFICATIONS

Eesti

Model	Siseseade	Välisseade
Funktsioon		
Toiteallikas		
Võimsus		kW
Sisend		kW
Kaal	Siseseade	kg
	Välisseade	kg
Külmaaine täitemaht (R32)		kg
IP-kood	Siseseade	
	Välisseade	
Lubatud ülemäärane töö rõhk	LP ps	MPa
	HP ps	MPa
Müratase (SPL)	Siseseade (eriti kõrge/kõrge/keskmise/madal)	dB(A)
	Välisseade	dB(A)

Hrvatski

Model	Unutarnja	Vanjska
Funkcija		
Napajanje		
Kapacitet		kW
Ulaz		kW
Težina	Unutarnja	kg
	Vanjska	kg
Kapacitet punjenja rashladnog sredstva (R32)		kg
IP kod	Unutarnja	
	Vanjska	
Dopušteni prekomjerni radni tlak	LP ps	MPa
	HP ps	MPa
Razina buke (SPL)	Unutarnja (vrlo visoko/visoko/srednje/nisko)	dB(A)
	Vanjska	dB(A)

Latviski

Modelis	Iekšējā iekārta	Ārējā iekārta
Funkcija		
Strāvas padeve		
Jauda		kW
Ieejas jauda		kW
Svars	Iekšējā iekārta	kg
	Ārējā iekārta	kg
Aukstumaģenta uzpildes tilpums (R32)		kg
IP kods	Iekšējā iekārta	
	Ārējā iekārta	
Atļautais maksimālais darba spiediens	Zemākais spiediens	MPa
	Augstākais spiediens	MPa
Troksņa līmenis (SPL)	Iekšējā iekārta (loti augsts/augsts/vidējs/zems)	dB(A)
	Ārējā iekārta	dB(A)

Srpski

Model	Unutrašnja jedinica	Spoljna jedinica
Funkcija		
Napajanje		
Kapacitet		kW
Ulazna snaga		kW
Težina	Unutrašnja jedinica	kg
	Spoljna jedinica	kg
Kapacitet punjenja rashladne tečnosti (R32)		kg
IP kod	Unutrašnja jedinica	
	Spoljna jedinica	
Maksimalni dozvoljeni radni pritisak	LP ps	MPa
	HP ps	MPa
Nivo buke (SPL)	Unutrašnja jedinica (Vrlo velika/Velika/Srednja/Mala)	dB(A)
	Spoljna jedinica	dB(A)

Lietuviškai

Modelis	Vidinis	Išorinis
Funkcija		
Maitinimas		
Galia		kW
Ivestis		kW
Svoris	Vidinis	kg
	Išorinis	kg
Šaltnešio užpildymo tūris (R32)		kg
IP kodas	Vidinis	
	Išorinis	
Leistinasis didžiausias veikimo slėgis	ŽS ps	MPa
	AS ps	MPa
Triukšmo lygis (SPL)	Viduje (Labai aukštas/Aukštas/Vidutinis/Žemas)	dB(A)
	Išorinis	dB(A)

Українська

Модель	Внутрішній	Зовнішній
Функція		
Живлення		
Потужність		кВт
На вході		кВт
Маса	Внутрішній	кг
	Зовнішній	кг
Місткість холодоагенту (R32)		кг
Код IP	Внутрішній	
	Зовнішній	
Дозволений максимальний робочий тиск	Низький тиск	МПа
	Високий тиск	МПа
Рівень шуму (SPL)	Внутрішній (надвисокий/високий/середній/низький)	dB(A)
	Зовнішній	dB(A)

SPECIFICATIONS

Guaranteed operating range

		Indoor	Outdoor
Cooling	Upper limit	32°C DB 23°C WB	46°C DB —
	Lower limit	21°C DB 15°C WB	-10°C DB —
Heating	Upper limit	27°C DB —	24°C DB 18°C WB
	Lower limit	20°C DB —	-10°C DB -11°C WB

Note:

Rating condition
Cooling — Indoor: 27°C DB, 19°C WB
Outdoor: 35°C DB
Heating — Indoor: 20°C DB
Outdoor: 7°C DB, 6°C WB

DB: Dry Bulb
WB: Wet Bulb

Garantierter Betriebsbereich [Deutsch]

		Innengerät	Außengerät
Kühlen	Obergrenze		
	Untergrenze		
Heizen	Obergrenze		
	Untergrenze		

Hinweis:

Bemessungsbedingung
Kühlen — Innengerät:
Außengerät:
Heizen — Innengerät:
Außengerät:

DB: Trockentemperatur
WB: Feuchttemperatur

Gamme opérationnelle garantie [Français]

		Interne	Externe
Refroidissement	Limite supérieure		
	Limite inférieure		
Chauffage	Limite supérieure		
	Limite inférieure		

Remarque :

Rendement
Refroidissement — Interne :
Externe :
Chauffage — Interne :
Externe :

DB: Bulbe sec
WB: Bulbe humide

Gegarandeerd werkbereik [Nederlands]

		Binnen	Buiten
Koelen	Bovengrens		
	Ondergrens		
Verwarmen	Bovengrens		
	Ondergrens		

Opmerking:

Temperatuurwaarden
Koelen — Binnen:
Buiten:
Verwarmen — Binnen:
Buiten:

DB: Droge temperatuur
WB: Natte temperatuur

Intervalo garantizado de funcionamiento [Español]

		Interior	Exterior
Refrigeración	Margen superior		
	Margen inferior		
Calefacción	Margen superior		
	Margen inferior		

Nota:

Condiciones nominales
Refrigeración — Interior:
Exterior:
Calefacción — Interior:
Exterior:

DB: Temperatura seca
WB: Temperatura húmeda

Gamma di funzionamento garantita [Italiano]

		Interno	Esterno
Raffreddamento	Limite superiore		
	Limite inferiore		
Riscaldamento	Limite superiore		
	Limite inferiore		

Nota:

Temperatura di funzionamento
Raffreddamento — Interno:
Esterno:
Riscaldamento — Interno:
Esterno:

DB: termometro a secco
WB: termometro bagnato

Εγγυημένη κλίμακα λειτουργίας [Ελληνικά]

		Εσωτερική	Εξωτερική
Ψύξη	Ανώτατο όριο		
	Κατώτατο όριο		
Θέρμανση	Ανώτατο όριο		
	Κατώτατο όριο		

Σημείωση:

Συνθήκες διαβάθμισης
Ψύξη — Εσωτερική:
Εξωτερική:
Θέρμανση — Εσωτερική:
Εξωτερική:

DB: Dry Bulb - Ξηρός βολβός
WB: Wet Bulb - Υγρός βολβός

Amplitude de funcionamento garantida [Português]

		Interior	Exterior
Arrefecimento	Limite superior		
	Limite inferior		
Aquecimento	Limite superior		
	Limite inferior		

Observação:

Condição normal
Arrefecimento — Interior:
Exterior:
Aquecimento — Interior:
Exterior:

DB: Bolbo seco
WB: Bolbo húmido

Garanteret operationsområde [Dansk]

		Indendørs	Udendørs
Afkøling	Øvre grænse		
	Nedre grænse		
Opvarmning	Øvre grænse		
	Nedre grænse		

Bemærk:

Nominal effekt
Afkøling — Indendørs:
Udendørs:
Opvarmning — Indendørs:
Udendørs:

DB: Tørtemperatur
WB: Vådtemperatur

Garanterat arbetsområde [Svenska]

		Inomhus	Utomhus
Kyla	Övre gräns		
	Undre gräns		
Värme	Övre gräns		
	Undre gräns		

Obs:

Märkdata
Kylning — Inomhus:
Utomhus:
Uppvärmning — Inomhus:
Utomhus:

DB: Torr lampa
WB: Våt lampa

Гарантиран работен диапазон [Български]

		Вътрешно тяло	Външно тяло
Охлаждане	Горна граница		
	Долна граница		
Отопление	Горна граница		
	Долна граница		

Забележка:

Експлоатационни параметри
Охлаждане — Вътрешно:
Външно:
Отопление — Вътрешно:
Външно:

DB: Сух балон
WB: Мокър балон

Gwarantowany zasięg roboczy [Polski]

		Jednostka wewnętrzna	Jednostka zewnętrzna
Chłodzenie	Górną granicę		
	Dolną granicę		
Ogrzewanie	Górną granicę		
	Dolną granicę		

Uwaga:

Warunki oceny
Chłodzenie — Jednostka wewnętrzna:
Jednostka zewnętrzna:
Ogrzewanie — Jednostka wewnętrzna:
Jednostka zewnętrzna:

DB: termometr suchy
WB: termometr mokry

Garantert driftsområde [Norsk]

		Inne	Ute
Avkjøling	Øvre grense		
	Nedre grense		
Oppvarming	Øvre grense		
	Nedre grense		

Merk:

Merketilstand
Avkjøling — Inne:
Ute:
Oppvarming — Inne:
Ute:

DB: Dry Bulb (Tørr kolbe)
WB: Wet Bulb (Våt kolbe)

SPECIFICATIONS

Taattu käyttöalue [Suomi]

		Sisäyksikkö	Ulkoyksikkö
Jäähdytys	Yläraja		
	Alaraja		
Lämmitys	Yläraja		
	Alaraja		

Huomautus: —

Luokitusehto
Jäähdytys — Sisällä:
Ulkona:
Lämmitys — Sisällä:
Ulkona:

DB: Kuiva hehkulamppu
WB: Märkä hehkulamppu

Garantovaný pracovný rozsah [Slovenčina]

		Interiérová jednotka	Exteriérová jednotka
Chladienie	Horná hranica		
	Dolná hranica		
Kúrenie	Horná hranica		
	Dolná hranica		

Poznámka: —

Menovité podmienky
Chladienie — Interiérová jednotka:
Exteriérová jednotka:
Kúrenie — Interiérová jednotka:
Exteriérová jednotka:

DB: suchý teplomer
WB: vlhký teplomer

Zajamčeni razpon delovanja [Slovenščina]

		Notranja enota	Zunanja enota
Hlajenje	Zgornja meja		
	Spodnja meja		
Gretje	Zgornja meja		
	Spodnja meja		

Opomba: —

Nazivne vrednosti
Hlajenje — Notranja enota:
Zunanja enota:
Gretje — Notranja enota:
Zunanja enota:

DB: Suh termometer
WB: Moker termometer

Tagatud tööulatus [Eesti]

		Siseseade	Välisseade
Jahutamine	Ülempiir		
	Alampiir		
Kütmine	Ülempiir		
	Alampiir		

Märkus. —

Määramistingimus
Jahutamine — Siseseade:
Välisseade:
Kütmine — Siseseade:
Välisseade:

DB: kuiv termomeeter
WB: märg termomeeter

Garantuojamas veikimo diapazonas [Lietuviškai]

		Vidinis	Išorinis
Vėsinimas	Viršutinė riba		
	Apatinė riba		
Šildymas	Viršutinė riba		
	Apatinė riba		

Pastaba. —

Veikimo sąlyga
Vėsinimas — Vidinis įrenginys:
Išorinis įrenginys:
Šildymas — Vidinis įrenginys:
Išorinis įrenginys:

DB: sausas termometras
WB: drėgnas termometras

Garantovani radni opseg [Srpski]

		Unutrašnja jedinica	Spoljna jedinica
Hlađenje	Gornja granica		
	Donja granica		
Grejanje	Gornja granica		
	Donja granica		

Napomena: —

Uslovi prilikom procene
Hlađenje — Unutrašnja jedinica:
Spoljna jedinica:
Grejanje — Unutrašnja jedinica:
Spoljna jedinica:

DB: Suvi termometar
WB: Vlažni termometar

Zaručený provozní rozsah [Čeština]

		Vnitřní	Vnější
Chlazení	Horní limit		
	Dolní limit		
Topení	Horní limit		
	Dolní limit		

Poznámka: —

Podmínky hodnocení
Chlazení — vnitřní:
vnější:
Topení — vnitřní:
vnější:

DB: Suchý teploměr
WB: Vlhký teploměr

Garantált működési tartomány [Magyar]

		Beltéri egység	Kültéri egység
Hűtés	Felső határérték		
	Alsó határérték		
Fűtés	Felső határérték		
	Alsó határérték		

Megjegyzés: —

Mérségi körülmények
Hűtés — Beltéri:
Kültéri:
Fűtés — Beltéri:
Kültéri:

DB: Száraz hőmérséklet
WB: Nedves hőmérséklet

Intervalul de funcționarea garantat [Română]

		Interior	Exterior
Răcire	Limita superioară		
	Limita inferioară		
Încălzire	Limita superioară		
	Limita inferioară		

Notă: —

Condiție nominală
Răcire — Interior:
Exterior:
Încălzire — Interior:
Exterior:

DB: Termometru uscat
WB: Termometru umed

Garantētais darbības diapazons [Latviski]

		Iekšējā iekārta	Ārējā iekārta
Dzesēšana	Augšējā robeža		
	Apakšējā robeža		
Apsilde	Augšējā robeža		
	Apakšējā robeža		

Piezīme. —

Aprēķina apstākļi
Dzesēšana — Iekšējā iekārta:
Ārējā iekārta:
Apsilde — Iekšējā iekārta:
Ārējā iekārta:

DB: sausais termometrs
WB: slapjais termometrs

Zajamčeni radni domet [Hrvatski]

		Unutarnja	Vanjska
Rashlađivanje	Gornje ograničenje		
	Donje ograničenje		
Grijanje	Gornje ograničenje		
	Donje ograničenje		

Napomena: —

Nazivno stanje
Rashlađivanje — Unutarnja:
Vanjska:
Grijanje — Unutarnja:
Vanjska:

DB: suhi termometar
WB: mokri termometar

Гарантований робочий діапазон [Українська]

		Внутрішній	Зовнішній
Охолодження	Верхня межа		
	Нижня межа		
Обігрів	Верхня межа		
	Нижня межа		

Примітка. —

Номинальні умови експлуатації
Охолодження — Внутрішній блок:
Зовнішній блок:
Обігрів — Внутрішній блок:
Зовнішній блок:

DB: сухий термометр
WB: вологий термометр

SPECIFICATIONS

Wi-Fi interface

Model	MAC-597IFB-E
Input Voltage	DC12.7 V (from indoor unit)
Power consumption	MAX. 2 W
Size H×W×D (mm)	73.5×41.5×18.5
Weight (g) (including cable)	42
Transmitter power level (MAX.)	20 dBm @IEEE 802.11b
RF channel	1ch ~ 13ch (2412 ~ 2472 MHz)
	0ch ~ 39ch (2402 ~ 2480 MHz)
Radio protocol	IEEE 802.11b/g/n (20)
Encryption	AES
Authentication	WPA2-PSK
Software Version	XX.00
For Declaration of Conformity, please go to the website.	http://www.mitsubishielectric.com/ldg/ibim/

Wi-Fi interface setting information

Indoor unit model name	
Indoor unit serial number	
Outdoor unit model name	
Outdoor unit serial number	
Wi-Fi interface MAC address (MAC)	
Wi-Fi interface serial number (ID)	
System commissioning date	
Wi-Fi interface installation date	

Installer contact details

Name	
Telephone number	

Wi-Fi-Schnittstelle [Deutsch]

Modell
Eingangsspannung
Leistungsaufnahme
Größe H×B×T (mm)
Gewicht (g) (einschließlich Kabel)
Sendeleistungspegel (MAX.)
Funkkanal
Funkprotokoll
Verschlüsselung
Authentifizierung
Softwareversion
Die Konformitätserklärung finden Sie auf der Website.

Interface Wi-Fi [Français]

Modèle
Tension d'entrée
Consommation
Dimensions H×L×P (mm)
Poids (g) (câble compris)
Niveau de puissance de l'émetteur (MAX.)
Canal RF
Protocole radio
Chiffrement
Authentification
Version du logiciel
Pour la Déclaration de conformité, veuillez consulter le site Web.

Wi-Fi interface [Nederlands]

Model
Ingangsvoltage
Stroomverbruik
Afmeting H×B×D (mm)
Gewicht (g) (inclusief kabel)
Zendervermogen (MAX.)
RF-kanaal
Radioprotocol
Encryptie
Authenticatie
Softwareversie
Ga naar de website voor de Declaration of Conformity (Conformiteitsverklaring).

Interfaz Wi-Fi [Español]

Modelo
Voltaje de entrada
Consumo de energía
Tamaño Alt. × Anch. × Prof. (mm)
Peso (g) (incluyendo el cable)
Nivel de potencia del transmisor (MÁX.)
Canal RF
Protocolo de radio
Cifrado
Autenticación
Versión del software
Si desea consultar la Declaración de conformidad, visite la página web.

Interfaccia Wi-Fi [Italiano]

Modello
Tensione in entrata
Assorbimento
Dimensioni LxAxP (mm)
Peso (g) (cavo incluso)
Livello di potenza trasmettitore (MAX.)
Canale RF
Protocollo radio
Cifatura
Autenticazione
Versione software
Per la Dichiarazione di conformità consultare il sito web.

Διαπαφή Wi-Fi [Ελληνικά]

Μοντέλο
Τάση εισόδου
Κατανάλωση ισχύος
Μέγεθος Υ×Π×Β (mm)
Βάρος (g) (συμπεριλαμβανομένου του καλωδίου)
Επίπεδο ισχύος πομπού (ΜΕΓ.)
Κανάλι RF
Ασύρματο πρωτόκολλο
Κρυπτογράφηση
Έλεγχος ταυτότητας
Έκδοση λογισμικού
Για τη Δήλωση συμμόρφωσης, μεταβείτε στον ιστότοπο.

Interface Wi-Fi [Português]

Modelo
Tensão de entrada
Consumo de energia
Dimensões A × L × P (mm)
Peso (g) (incluindo o cabo)
Potência do transmissor (MÁX.)
Canal de RF
Protocolo de rádio
Encriptação
Autenticação
Versão do software
Para obter a Declaração de Conformidade, acesse o site.

Wi-Fi-interface [Dansk]

Model
Indgangsspænding
Strømförbrug
Størrelse H×B×D (mm)
Vægt (g) (inkl. kabel)
Senderens effektniveau (MAKS.)
RF-kanal
Radioprotokol
Kryptering
Godkendelse
Softwareversion
Overensstemmelseserklæringen findes ved at gå ind på hjemmesiden.

Wi-Fi-gränssnitt [Svenska]

Modell
Ingående spänning
Effektförbrukning
Storlek H×B×D (mm)
Vikt (g) (inklusive kabel)
Effektnivå för sändare (MAX.)
RF-kanal
Radioprotokoll
Kryptering
Autentisering
Programvaruversion
För Försäkringen om överensstämmelse, gå till webbplatsen.

SPECIFICATIONS

Wi-Fi интерфейс [Български]

Модел
Входно напрежение
Консумирана мощност
Размери В × Ш × Д (mm)
Тегло (g) (включително кабела)
Ниво на мощност на предавателя (МАКС.)
Радиочестотен канал
Радиопротокол
Шифроване
Удостоверяване
Версия на софтуера
За декларацията за съответствие посетете уебсайта.

Wi-Fi-liitäntä [Suomi]

Malli
Syöttöjännite
Virrankulutus
Koko K × L × S (mm)
Paino (g) (mukaan lukien kaapeli)
Lähettimen tehotas (MAKS.)
RF-kanava
Radioprotokolla
Salaus
Todennus
Ohjelmistoversio
Vaatimustenmukaisuusvakuutus on tässä osoit- teessa.

Wi-Fi csatlakozó [Magyar]

Modell
Bemeneti feszültség
Teljesítményfelvétel
Méreték Ma×Szé×Mé (mm)
Tömeg (g) (kábelrel együtt)
Adó teljesítményszintje (MAX.)
RF csatorna
Rádió protokoll
Titkosítás
Azonosítás
Szoftververzió
A Megfelelőségi nyilatkozat a weboldalon található.

Wi-Fi-liides [Eesti]

Mudel
Sisendpinge
Energiatarve
Suurus K × L × S (mm)
Kaal (g) (koos kaabliga)
Saatja võimsustase (MAX)
RF-kanal
Raadioprotokoll
Krüpteering
Autentimine
Tarkvara versioon
Vastavusdeklaratsiooni leiate veebisaidilt.

Wi-Fi sučelje [Hrvatski]

Model
Ulazni napon
Potrošnja energije
Veličina V×Š×D (mm)
Težina (g) (uključujući kabel)
Razina snage odašiljača (NAJV.)
RF kanal
Radijski protokol
Šifriranje
Provjera autentičnosti
Verzija softvera
Izjavu o sukladnosti pronađite na mrežnom mjestu.

Interfejs Wi-Fi [Polski]

Model
Napięcie wejściowe
Zużycie energii
Wymiary Wys.×Szer.×Gł. (mm)
Masa (g) (z kablem)
Poziom mocy nadajnika (MAKS.)
Kanał RF
Protokół radiowy
Szyfrowanie
Uwierzytelnianie
Wersja oprogramowania
Deklarację zgodności można znaleźć na stronie internetowej.

Rozhraní Wi-Fi [Čeština]

Model
Vstupní napětí
Spotřeba elektrické energie
Velikost V×Š×H (mm)
Hmotnost (g) (včetně kabelu)
Výstupní výkon vysílače (MAX.)
RF kanál
Rádiový protokol
Šifrování
Autentizace
Verze softwaru
Prohlášení o shodě najdete na webových strán- kách.

Brezžični vmesnik Wi-Fi [Slovenščina]

Model
Vhodna napetost
Električna poraba
Velikost V × Š × G (mm)
Teža (g) (vkjučno s kablom)
Jakost oddajnika (NAJV.)
RF-kanal
Radiofrekvenčni protokol
Šifriranje
Preverjanje pristnosti
Različica programske opreme
Izjavo o skladnosti najdete na spletnem mestu.

Wi-Fi saskarne [Latviski]

Modelis
Ievades spriegums
Strāvas patēriņš
Izmērs A × P × G (mm)
Svars (g) (ar kabeli)
Raidītāja jaudas līmenis (maks.)
Radiofrekvences josla
Radio protokols
Šifrēšana
Autentifikācija
Programmatūras versija
Atbilstības deklarāciju varat skatīt tīmekļa vietnē.

Wi-Fi interfejs [Srpski]

Model
Ulazni napon
Potrošnja struje
Veličina V×Š×D (mm)
Težina (g) (uključujući kabel)
Nivo snage predajnika (MAKS.)
RF kanal
Radio protokol
Enkripcija
Potvrda identiteta
Verzija softvera
Izjavu o usaglašenosti možete pronaći na veb stranici.

Wi-Fi-grensesnitt [Norsk]

Modell
Inngangsspenning
Strømforbruk
Mål H×B×D (mm)
Vekt (g) (inkl. kabel)
Effektivnivå for sender (MAKS.)
RF-kanal
Radioprotokoll
Kryptering
Autentisering
Programvareversjon
Du finner samsvarserklæringen på nettsiden.

Rozhranie Wi-Fi [Slovenčina]

Model
Vstupné napätie
Spotreba prúdu
Rozmery V × Š × D (mm)
Hmotnosť (g) (vrátane kábla)
Výkonová hladina vysielača (MAX.)
VF kanál
Rozhlasový protokol
Šifrovanie
Overovanie
Verzia softvéru
Vyhlasenie o zhode nájdete na tejto webovej stránke.

Interfață Wi-Fi [Română]

Model
Tensiune de intrare
Consumul de energie electrică
Dimensiune Î×L×D (mm)
Greutate (g) (inclusiv cablu)
Nivel de putere emițător (MAX.)
Canal RF
Protocol radio
Criptare
Autentificare
Versiune de software
Pentru Declarația de conformitate, vă rugăm să accesați site-ul web.

„Wi-Fi“ sąsaja [Lietuviškai]

Modelis
Išvedama įtampa
Galios sąnaudos
Dydis A×P×G (mm)
Svoris (g) (įskaitant kabelį)
Siųstuvo galios lygis (MAKS.)
RF kanalas
Radio protokolas
Šifravimas
Autentifikavimas
Programinės įrangos versija
Norėdami gauti Atitikties deklaraciją, apsilankykite žiniatinklio svetainėje.

Интерфейс Wi-Fi [Українська]

Модель
Напруга на вході
Енергоспоживання
Розмір В×Ш×Г (мм)
Вага (г) (разом із кабелем)
Рівень потужності передавача (МАКС.)
Радіоканал
Протокол радіообміну
Шифрування
Автентифікація
Версія програмного забезпечення
Стосовно Декларації про відповідність, перейдіть на вебсайт.

UK DECLARATION OF CONFORMITY

MITSUBISHI ELECTRIC AIR CONDITIONING SYSTEMS MANUFACTURING TURKEY JOINT STOCK COMPANY.
Manisa OSB 4.Kisim Kecilikoyosb Mah.
Ahmet Nazif Zorlu Bulvari No:19 Yunusemre - Manisa.

hereby declares under its sole responsibility that the air conditioner(s) and heat pump(s) for use in residential, commercial, and light-industrial environments described below:

MITSUBISHI ELECTRIC, MSZ-HR25VF2/MUZ-HR25VF2
MSZ-HR35VF2/MUZ-HR35VF2
MSZ-HR42VF2/MUZ-HR42VF2
MSZ-HR50VF2/MUZ-HR50VF2

is/are in conformity with provisions of the following UK legislation

The Electrical Equipment (Safety)Regulations 2016
The Supply of Machinery (Safety)Regulations 2008
The Electromagnetic Compatibility Regulations 2016
The Restriction of the Use of Certain Hazardous Substances in Electrical and Electronic Equipment Regulations 2012

Issued: **1 June, 2025** **Kenichi SAITO**
TURKEY **Quality Assurance Department**

UK DECLARATION OF CONFORMITY

MITSUBISHI ELECTRIC AIR CONDITIONING SYSTEMS MANUFACTURING TURKEY JOINT STOCK COMPANY.
Manisa OSB 4.Kisim Kecilikoyosb Mah.
Ahmet Nazif Zorlu Bulvari No:19 Yunusemre - Manisa.

hereby declares under its sole responsibility that the air conditioner(s) and heat pump(s) for use in residential, commercial, and light-industrial environments described below:

MITSUBISHI ELECTRIC, MSZ-HR25VFK2/MUZ-HR25VF2
MSZ-HR35VFK2/MUZ-HR35VF2
MSZ-HR42VFK2/MUZ-HR42VF2
MSZ-HR50VFK2/MUZ-HR50VF2

is/are in conformity with provisions of the following UK legislation

The Radio Equipment Regulations 2017
The Supply of Machinery (Safety)Regulations 2008
The Restriction of the Use of Certain Hazardous Substances in Electrical and Electronic Equipment Regulations 2012

Issued: **1 June, 2025** **Kenichi SAITO**
TURKEY **Quality Assurance Department**

EU DECLARATION OF CONFORMITY
EU-KONFORMITÄTSESKLÄRUNG
DÉCLARATION DE CONFORMITÉ UE
EU-CONFORMITEITSVERKLARING
DECLARACIÓN DE CONFORMIDAD UE
DICHIARAZIONE DI CONFORMITÀ UE
ΔΗΛΩΣΗ ΣΥΜΜΟΡΦΩΣΗΣ ΕΕ
DECLARAÇÃO DE CONFORMIDADE UE
EU-OVERENSSTEMMELSESERKLÆRING

EG-DEKLARATION OM ÖVERENSSTÄMMELSE
AB UYGUNLUK BEYANI
ЕС ДЕКЛАРАЦИЯ ЗА СЪОТВЕТСТВИЕ
DEKLARACJA ZGODNOŚCI UE
EU-ERKLÆRING OM SAMSVAR
EU-VAATIMUSTENMUKAISUUSVAKUUTUS
EU PROHLÁŠENÍ O SHODĚ
EU VYHLÁŠENIE O ZHODE
EU MEGFELELŐSÉGI NYILATKOZAT

IZJAVA EU O SKLADNOSTI
DECLARAȚIE DE CONFORMITATE UE
EL-I VASTAVUSDEKLARATSIOON
ES ATBILSTĪBAS DEKLARĀCIJA
ES ATITIKTIES DEKLARACIJA
EU IZJAVA O SUKLADNOSTI
EU IZJAVA O USAGLAŠENOSTI

MITSUBISHI ELECTRIC AIR CONDITIONING SYSTEMS MANUFACTURING TURKEY JOINT STOCK COMPANY.

Manisa OSB 4.Kisim Kecilikoyosb Mah.

Ahmet Nazif Zorlu Bulvari No:19 Yunusemre - Manisa.

hereby declares under its sole responsibility that the air conditioner(s) and heat pump(s) for use in residential, commercial, and light-industrial environments described below:
erklärt hiermit auf seine alleinige Verantwortung, dass die Klimaanlage(n) und Wärmepumpe(n) für das häusliche, kommerzielle und leichtindustrielle Umfeld wie unten beschrieben:
déclare par la présente et sous sa propre responsabilité que le(s) climatiseur(s) et la/les pompe(s) à chaleur destinés à un usage dans des environnements résidentiels, commerciaux et d'industrie légère décrits ci-dessous :

verklaart hierbij onder eigen verantwoordelijkheid dat de voor huishoudelijke, handels- en lichtindustriële omgevingen bestemde airconditioner(s) en warmtepomp(en) zoals onderstaand beschreven:

por la presente declara, bajo su exclusiva responsabilidad, que el(los) acondicionador(es) de aire y la(s) bomba(s) de calor previsto(s) para su uso en entornos residenciales, comerciales y de industria ligera que se describen a continuación:

conferma con la presente, sotto la sua esclusiva responsabilità, che i condizionatori d'aria e le pompe di calore destinati all'utilizzo in ambienti residenziali, commerciali e semi-industriali e descritti di seguito:

με το παρόν δηλώνω με αποκλειστική ευθύνη ότι το ή τα κλιματιστικά και η ή οι αντλίες θερμότητας για χρήση σε οικιακά, εμπορικά και ελαφρά βιομηχανικά περιβάλλοντα που περιγράφονται παρακάτω:

declara pela presente, e sob sua exclusiva responsabilidade, que o(s) aparelho(s) de ar condicionado e a(s) bomba(s) de calor destinados a utilização em ambientes residenciais, comerciais e de indústria ligeira descritos em seguida:

erklærer hermed under eneansvar, at det/de herunder beskrevne airconditionanlæg og varmepumpe(r) til brug i beboelses- og erhvervs miljøer samt i miljøer med let industri intygar härmed att luftkonditioneringarna och varmepumparna som beskrivs nedan för användning i bostäder, kommersiella miljöer och lätta industriella miljöer:

ev, ticaret ve hafif sanayi ortamlarında kullanıma yönelik aşağıda açıklanan klima ve ısıtma pompalarını ilgili aşağıdaki hususları yalnızca kendi sorumluluğunda olmak üzere beyan eder:

декларира с настоящата на своя собствена отговорност, че климатикъ(те) и термомпата(ите), посочени по-долу и предназначени за употреба в жилищни, търговски и лекопромишлени среди:

niniejszym oświadczam na swoją wyłączną odpowiedzialność, że klimatyzatory i pompy ciepła do zastosowań w środowisku mieszkalnym, handlowym i lekko uprzemysłowionym opisane poniżej:

erklærer et fullstendig ansvar for undernevnte klimaanlegg og varmepumper ved bruk i boliger, samt kommersielle og lettindustrielle miljøer:

vakuuttaa täten yksinomaisella vastuullaan, että jäljempänä kuvattut asuinrakennuksiin, pientaloisuuskäyttöön ja kaupalliseen käyttöön tarkoitettut ilmastointilaitteet ja lämpöpumput: tímto na vlastní odpovědnost prohlašuje, že níže popsané klimatizační jednotky a tepelná čerpadla pro použití v obytných prostedích, komerčních prostedích a prostedích lehkého průmyslu:

týmto na svoju výlučnú zodpovednosť vyhlasuje, že nasledovné klimatizačné jednotky a tepelné čerpadlá určené na používanie v obytných a obchodných priestoroch a v prostredí ľahkého priemyslu:

alulírott kizárólagos felelősségére nyilatkozik, hogy az alábbi lakossági, kereskedelmi és kisipari környezetben való használatra szánt klímaberendezés(ek) és hőszivattyú(k):

na lastno odgovornost izjavlja, da so spodaj opisane klimatske naprave in toplotne črpalke, namenjene za uporabo v stanovanjskih, poslovnih in lahkoindustrijskih okoljih: declară prin prezenta, pe proprie răspundere, faptul că aparatele de climatizare și pompele de căldură descrie mai jos și destinate utilizării în medii rezidențiale, comerciale și din industria ușoară:

kinnitab oma ainuvastutuse, et allpool toodud elu-, äri- ja kergtööstuskeskkondades kasutamiseks mõeldud kliimaseadmed ja soojuspumbad: ar šo, vienpersoniski uzņemoties atbildību, paziņo, ka tālāk aprakstītais(-tie) gaisa kondicionētājs(-i) ir paredzēti lietošanai dzīvojamajās, komercdarbības un vieglās rūpniecības telpās, kas aprakstītas tālāk:

šiuo vien tik savo atsakomybe pareiškia, kad toliau apibūdintais (-iai) oro kondicionierius (-iai) ir šilumos siurblys (-iai), skirtas (-i) naudoti toliau apibūdintose gyvenamosiose, komercinėse ir lengvosios pramonės aplinkose:

ovime izjavljuje pod isključivom odgovornošću da je/su klimatizacijski uređaj(i) i toplinska dizalica(e) opisan(i) u nastavku namijenjen(i) za upotrebu u stambenim i poslovnim okruženjima te okruženjima lake industrije:

ovim izjavljuje na svoju isključivu odgovornost da su klima-uređaji i toplotne pumpe za upotrebu u stambenim, komercijalnim okruženjima i okruženjima lake industrije opisani u nastavku:

**MITSUBISHI ELECTRIC, MSZ-HR25VF2/MUZ-HR25VF2
MSZ-HR35VF2/MUZ-HR35VF2
MSZ-HR42VF2/MUZ-HR42VF2
MSZ-HR50VF2/MUZ-HR50VF2**

is/are in conformity with provisions of the following Union harmonisation legislation.
die Bestimmungen der folgenden Harmonisierungsrechtsvorschriften der Union erfüllt/ erfüllen.
est/son conforme(s) aux dispositions de la législation d'harmonisation de l'Union suivante.
voldoet/voldoen aan bepalingen van de volgende harmonisatiewetgeving van de Unie.
cumple(n) con las disposiciones de la siguiente legislación de armonización de la Unión.
sono in conformità con le disposizioni della seguente normativa dell'Unione sull'armonizzazione.
συμμορφώνονται με τις διατάξεις της ακόλουθης νομοθεσίας εναρμόνισης της Ένωσης.
está/estão em conformidade com as disposições da seguinte legislação de harmonização da União.
er i overensstemmelse med bestemmelserne i følgende harmoniserede EU-lovgivning.
oppfyller villkoren i följande harmoniserade föreskrifter inom unionen.
aşağıdaki Avrupa Birliği uyumlaştırma mevzuatının hükümlerine uygundur.
е/са в съответствие с разпоредбите на следното законодателство на Съюза за хармонизация.

są zgodne z przepisami następującego unijnego prawodawstwa harmonizacyjnego.
er i samsvar med forskriftene til følgende EU-lovgivning om harmonisering.
ovat seuraavan unionin yhdenmukaistamislaainsäädännön säännösten mukaisia.
jsou v souladu s ustanoveními následujících harmonizačních právních předpisů Unie.
splňajú ustanovenia nasledujúcich harmonizovaných noriem EÚ.
megfelel(nek) az Unió alábbi harmonizációs jogszabályi előírásainak.
v skladu z določbami naslednje usklajevalne zakonodaje Unije.
sunt în conformitate cu dispozițiile următoare legislației de armonizare a Uniunii.
vastavad järgmiste Euroopa Liidu ühtlustatud õigusaktide sätetele.
atbilst šādiem ES harmonizētajiem tiesību aktu noteikumiem.
taip pat atitinka kitų toliau išvardytų suderintųjų Sąjungos direktyvų nuostatas.
sukladan(i) odredbama sljedećeg zakonodavstva Unije za sukladnost.
u skladu sa odredbama sledećeg usklađivanja zakonodavstva Unije.

Directives	Direttive	Direktifler	Směrnice	Direktívid	Директиви
Richtlinien	Οδηγίες	Директиви	Smernice	Direktivas	Директиви
Directives	Directivas	Dyrektwy	Irányelvek	Diretyvos	
Richtlijnen	Direktiver	Direktiver	Direktive	Direktive	
Directivas	Direktiv	Direktiivit	Directive	Direktive	

2014/35/EU: Low Voltage Directive
2006/42/EC: Machinery Directive
2014/30/EU: Electromagnetic Compatibility Directive
2011/65/EU, (EU) 2015/863 and (EU) 2017/2102: RoHS Directive

Issued: 1 June, 2025
TURKEY

Kenichi SAITO
Quality Assurance Department

EU DECLARATION OF CONFORMITY
EU-KONFORMITÄTSESKLÄRUNG
DÉCLARATION DE CONFORMITÉ UE
EU-CONFORMITEITSVERKLARING
DECLARACIÓN DE CONFORMIDAD UE
DICHIARAZIONE DI CONFORMITÀ UE
ΔΗΛΩΣΗ ΣΥΜΜΟΡΦΩΣΗΣ ΕΕ
DECLARAÇÃO DE CONFORMIDADE UE
EU-OVERENSSTEMMELSESERKLÆRING

EG-DEKLARATION OM ÖVERENSSTÄMMELSE
AB UYGUNLUK BEYANI
ЕС ДЕКЛАРАЦИЯ ЗА СЪОТВЕТСТВИЕ
DEKLARACJA ZGODNOŚCI UE
EU-ERKLÆRING OM SAMSVAR
EU-VAATIMUSTENMUKAISUUSVAKUUTUS
EU PROHLÁŠENÍ O SHODĚ
EU VYHLÁŠENIE O ZHODE
EU MEGFELELŐSÉGI NYILATKOZAT

IZJAVA EU O SKLADNOSTI
DECLARAȚIE DE CONFORMITATE UE
EL-I VASTAVUSDEKLARATSIOON
ES ATBILSTĪBAS DEKLARĀCIJA
ES ATITIKTIES DEKLARACIJA
EU IZJAVA O SUKLADNOSTI
EU IZJAVA O USAGLAŠENOSTI

MITSUBISHI ELECTRIC AIR CONDITIONING SYSTEMS MANUFACTURING TURKEY JOINT STOCK COMPANY.

Manisa OSB 4.Kisim Kecilikoyosb Mah.

Ahmet Nazif Zorlu Bulvari No:19 Yunusemre - Manisa.

hereby declares under its sole responsibility that the air conditioner(s) and heat pump(s) for use in residential, commercial, and light-industrial environments described below:
erklärt hiermit auf seine alleinige Verantwortung, dass die Klimaanlage(n) und Wärmepumpe(n) für das häusliche, kommerzielle und leichtindustrielle Umfeld wie unten beschrieben:
déclare par la présente et sous sa propre responsabilité que le(s) climatiseur(s) et la/les pompe(s) à chaleur destinés à un usage dans des environnements résidentiels, commerciaux et d'industrie légère décrits ci-dessous :

verklaart hierbij onder eigen verantwoordelijkheid dat de voor huishoudelijke, handels- en lichtindustriële omgevingen bestemde airconditioner(s) en warmtepomp(en) zoals onderstaand beschreven:

por la presente declara, bajo su exclusiva responsabilidad, que el(los) acondicionador(es) de aire y la(s) bomba(s) de calor previsto(s) para su uso en entornos residenciales, comerciales y de industria ligera que se describen a continuación:

conferma con la presente, sotto la sua esclusiva responsabilità, che i condizionatori d'aria e le pompe di calore destinati all'utilizzo in ambienti residenziali, commerciali e semi-industriali e descritti di seguito:

με το παρόν δηλώνω με αποκλειστική ευθύνη ότι το ή τα κλιματιστικά και η ή οι αντλίες θερμότητας για χρήση σε οικιακά, εμπορικά και ελαφρά βιομηχανικά περιβάλλοντα που περιγράφονται παρακάτω:

declara pela presente, e sob sua exclusiva responsabilidade, que o(s) aparelho(s) de ar condicionado e a(s) bomba(s) de calor destinados a utilização em ambientes residenciais, comerciais e de indústria ligeira descritos em seguida:

erklærer hermed under eneansvar, at det/de herunder beskrevne airconditionanlæg og varmepumpe(r) til brug i beboelses- og erhvervmiljøer samt i miljøer med let industri intygar härmed att luftkonditioneringarna och varmepumparna som beskrivs nedan för användning i bostäder, kommersiella miljöer och lätta industriella miljöer:

ev, ticaret ve hafif sanayi ortamlarında kullanıma yönelik aşağıda açıklanan klima ve ısıtma pompalarını ilgili aşağıdaki hususları yalnızca kendi sorumluluğunda olmak üzere beyan eder:

декларира с настоящата на своя собствена отговорност, че климатикъ(те) и термомпата(ите), посочени по-долу и предназначени за употреба в жилищни, търговски и лекотомпромишлени среди:

niniejszym oświadczam na swoją wyłączną odpowiedzialność, że klimatyzatory i pompy ciepła do zastosowań w środowisku mieszkalnym, handlowym i lekko uprzemysłowionym opisane poniżej:

erklærer et fullstendig ansvar for undernevnte klimaanlegg og varmepumper ved bruk i boliger, samt kommersielle og lettindustrielle miljøer:

vakuuttaa täten yksinomaisella vastuullaan, että jäljempänä kuvutat asuinrakennuksiin, pientaloisuuskäyttöön ja kaupalliseen käyttöön tarkoitettut ilmastointilaitteet ja lämpöpumput: tímto na vlastní odpovědnost prohlašuje, že níže popsané klimatizační jednotky a tepelná čerpadla pro použití v obytných prostedích, komerčních prostedích a prostedích lehkého prumyslu:

týmto na svoju výlučnú zodpovednosť vyhlasuje, že nasledovné klimatizačné jednotky a tepelné čerpadlá určené na používanie v obytných a obchodných priestoroch a v prostredí ľahkého priemyslu:

alulírott kizárólagos felelősségére nyilatkozik, hogy az alábbi lakossági, kereskedelmi és kisipari környezetben való használatra szánt klímaberendezés(ek) és hőszivattyú(k):

na lastno odgovornost izjavlja, da so spodaj opisane klimatske naprave in toplotne črpalke, namenjene za uporabo v stanovanjskih, poslovnih in lahkoindustrijskih okoljih: declară prin prezenta, pe proprie răspundere, faptul că aparatele de climatizare și pompele de căldură descrie mai jos și destinate utilizării în medii rezidențiale, comerciale și din industria ușoară:

kinnitab oma ainuvastutuse, et allpool toodud elu-, äri- ja kergtööstuskeskkondades kasutamiseks mõeldud kliimaseadmed ja soojuspumbad: ar šo, vienpersoniski uzņemoties atbildību, paziņo, ka tālāk aprakstītais(-tie) gaisa kondicionētājs(-i) un siltumsūkņis(-i) ir paredzēti lietošanai dzīvojamajās, komercdarbības un vieglās rūpniecības telpās, kas aprakstītas tālāk:

šiuo vien tik savo atsakomybe pareiškia, kad toliau apibūdintais (-iai) oro kondicionierius (-iai) ir šilumos siurblys (-iai), skirtas (-i) naudoti toliau apibūdintose gyvenamosiose, komercinėse ir lengvosios pramonės aplinkose:

ovime izjavljuje pod isključivom odgovornošću da je/su klimatizacijski uređaj(i) i toplinska dizalica(e) opisan(i) u nastavku namijenjen(i) za upotrebu u stambenim i poslovnim okruženjima te okruženjima lake industrije:

ovim izjavljuje na svoju isključivu odgovornost da su klima-uređaji i toplotne pumpe za upotrebu u stambenim, komercijalnim okruženjima i okruženjima lake industrije opisani u nastavku:

**MITSUBISHI ELECTRIC, MSZ-HR25VFK2/MUZ-HR25VF2
MSZ-HR35VFK2/MUZ-HR35VF2
MSZ-HR42VFK2/MUZ-HR42VF2
MSZ-HR50VFK2/MUZ-HR50VF2**

is/are in conformity with provisions of the following Union harmonisation legislation.
die Bestimmungen der folgenden Harmonisierungsrechtsvorschriften der Union erfüllt/ erfüllen.
est/sont conforme(s) aux dispositions de la législation d'harmonisation de l'Union suivante.
voldoet/voldoen aan bepalingen van de volgende harmonisatiewetgeving van de Unie.
cumple(n) con las disposiciones de la siguiente legislación de armonización de la Unión.
sono in conformità con le disposizioni della seguente normativa dell'Unione sull'armonizzazione.
συμμορφώνονται με τις διατάξεις της ακόλουθης νομοθεσίας εναρμόνισης της Ένωσης.
está/estão em conformidade com as disposições da seguinte legislação de harmonização da União.
er i overensstemmelse med bestemmelserne i følgende harmoniserede EU-lovgivning.
uppfyller villkoren i följande harmoniserade föreskrifter inom unionen.
aşağıdaki Avrupa Birliği uyumlaştırma mevzuatının hükümlerine uygundur.
е/са в съответствие с разпоредбите на следното законодателство на Съюза за хармонизация.

są zgodne z przepisami następującego unijnego prawodawstwa harmonizacyjnego.
er i samsvar med forskriftene til følgende EU-lovgivning om harmonisering.
ovat seuraavan unionin yhdenmukaistamisläisäädännön säännösten mukaisia.
jsou v souladu s ustanoveními následujících harmonizačních právních předpisů Unie.
splňajú ustanovenia nasledujúcich harmonizovaných noriem EÚ.
megfelelnek az Unió alábbi harmonizációs jogszabályi előírásainak.
v skladu z določbami naslednje usklajevalne zakonodaje Unije.
sunt în conformitate cu dispozițiile următoare legislației de armonizare a Uniunii.
vastavad järgmiste Euroopa Liidu ühtlustatud õigusaktide sätetele.
atbilst šādiem ES harmonizētajiem tiesību aktu noteikumiem.
taip pat atitinka kitų toliau išvardytų suderintųjų Sąjungos direktyvų nuostatas.
sukladan(i) odredbama sljedećeg zakonodavstva Unije za skladnost.
u skladu sa odredbama sledećeg usklađivanja zakonodavstva Unije.

Directives	Direttive	Direktifler	Směrnice	Direktīvid	Директиви
Richtlijnen	Oδηγίες	Директиви	Smernice	Direktīvas	Директиви
Directives	Directivas	Dyrektywy	Irányelvek	Direktīvos	
Richtlijnen	Direktiver	Direktiver	Direktive	Direktive	
Directivas	Direktiv	Direktiiv	Directive	Direktive	

2014/53/EU: Radio Equipment Directive
2006/42/EC: Machinery Directive
2011/65/EU, (EU) 2015/863 and (EU) 2017/2102: RoHS Directive

Issued: 1 June, 2025
TURKEY

Kenichi SAITO
Quality Assurance Department

MITSUBISHI ELECTRIC CORPORATION

HEAD OFFICE: TOKYO BUILDING, 2-7-3, MARUNOUCHI, CHIYODA-KU, TOKYO 100-8310, JAPAN

DG79A0F9H01